



PARISOT INDUSTRIE

**WINTER
2025**



SUMMARY

WINTER 2025

KID BEDROOMS

| | |
|----------------------|----|
| AALBORG..... | 2 |
| ACHILLE..... | 4 |
| ALEXANDRA..... | 6 |
| BIBLIOBED..... | 8 |
| CHARLY..... | 10 |
| CLEO..... | 12 |
| ESCALE..... | 14 |
| FABRIC..... | 16 |
| FINLAND..... | 18 |
| HEAVY..... | 20 |
| HIGHER..... | 22 |
| JADE..... | 24 |
| LEO..... | 26 |
| LUCAS..... | 28 |
| MILKY..... | 30 |
| NASHVILLE..... | 32 |
| ONLINE..... | 34 |
| PIROUETTE..... | 36 |
| REVERSE..... | 40 |
| SHELTER..... | 41 |
| SHELTER CELADON..... | 49 |
| SLEEP..... | 51 |
| SMOOZY..... | 53 |
| STIM 2..... | 55 |
| TOBO..... | 57 |
| TOM..... | 59 |

ADULT BEDROOMS

| | |
|----------------|----|
| AALBORG..... | 62 |
| ACHILLE..... | 64 |
| BIANCA..... | 66 |
| BRIDGE..... | 67 |
| DREAM..... | 69 |
| EKKO..... | 71 |
| ESCALE..... | 73 |
| HORN..... | 75 |
| LODGE..... | 77 |
| MOST..... | 79 |
| NASHVILLE..... | 81 |
| PALANTE..... | 83 |
| SOLUCE..... | 85 |
| STAMP..... | 87 |
| TORONTO..... | 91 |
| TRAVEL..... | 93 |

LIVING ROOMS

| | |
|-----------------|-----|
| EWEN..... | 96 |
| FUMAY..... | 98 |
| LEVIATHAN..... | 100 |
| LUNDGE..... | 101 |
| MAELLE..... | 103 |
| MORPHOS..... | 105 |
| PARADOXE..... | 107 |
| PORTLAND 2..... | 109 |
| SOPHIA..... | 111 |
| THEBES..... | 113 |
| TOMY 3..... | 114 |
| TRAVIS..... | 115 |
| WENDY..... | 116 |

STORAGE & FURNITURE

| | |
|--------------|-----|
| CELEST..... | 119 |
| DAILY 2..... | 121 |
| GALAXY..... | 123 |
| GAMING..... | 125 |
| GHOST..... | 127 |
| LUDIK..... | 128 |
| MAYENCE..... | 129 |
| MILO..... | 131 |
| MINKEE..... | 132 |
| NEO..... | 134 |
| ORLANDO..... | 136 |
| OSAKA..... | 137 |
| SOPHIA..... | 138 |

DRESSING

| | |
|-------------------|-----|
| BALI..... | 141 |
| BALI INDUS..... | 143 |
| BARI..... | 145 |
| CHICAGO..... | 147 |
| COMBI..... | 149 |
| COMBI INDUS..... | 151 |
| CORIDO..... | 153 |
| COSY..... | 155 |
| EXTENSO..... | 157 |
| EXTO..... | 160 |
| GARY..... | 162 |
| KIT VERRIERE..... | 164 |
| MODULIX..... | 166 |
| PLAY..... | 168 |
| PRIMA..... | 170 |
| SOUS COMBLE..... | 172 |
| TANGO..... | 174 |

DESKS

| | |
|---------------|-----|
| BEGIN..... | 177 |
| ESCALE..... | 178 |
| GAMING..... | 179 |
| INFINITY..... | 181 |
| LEVEL..... | 183 |
| MILO..... | 185 |
| MINISTER..... | 186 |
| MISTER..... | 187 |
| PALOMA..... | 188 |
| SET UP..... | 189 |
| SILVER..... | 191 |
| START UP..... | 193 |

BEAUTY BARS

| | |
|---------------|-----|
| PRECIOUS..... | 196 |
| SWEET..... | 198 |
| VOLAGE..... | 199 |

KITCHENS

| | |
|-----------------|-----|
| ANNA..... | 201 |
| BRUNCH..... | 203 |
| COTTAGE..... | 205 |
| EKO..... | 207 |
| ESSENTIEL..... | 209 |
| FUMAY..... | 211 |
| GALA..... | 215 |
| HUB..... | 217 |
| MALICE..... | 219 |
| MALO..... | 221 |
| MOOVE..... | 222 |
| SOCOOL..... | 224 |
| SOUS EVIER..... | 225 |
| SPOON..... | 226 |
| STUDIO..... | 229 |
| UNO..... | 230 |
| WAVE..... | 236 |

SANITARY

| | |
|--------------|-----|
| FLASH 2..... | 239 |
| GLAM..... | 241 |
| LAUNDRY..... | 243 |
| LONDY..... | 245 |
| UNO..... | 247 |
| WOODY..... | 249 |



KID BEDROOMS

KID BEDROOM / Aalborg



✦ The AALBORG bedroom comes in a children's version to suit all ages!

✦ The range includes a 90x200cm bed and clever storage, with a dressing area and chest of drawers that can be stacked to save space or placed side by side to fit into attics. Need more storage? The 3-door wardrobe will give you even more storage space!

✦ With its clean lines and compass legs, the Aalborg collection will win you over with its **Japanese Oak** and **White** colour combinations. Its mixed look will look great in either your boy's or girl's bedroom!



*The products are made in particleboard with a thickness of 12, 15 and 22 mm
The drawers are equipped with a roller runner systems*

WHITE

JAPANESE OAK

KID BEDROOM / Aalborg



The AALBORG Scandinavian children's bedroom includes :

- A 90x200cm bed with a H84 cm headboard included
- 56 cm high bedside unit with drawer and storage niche
- A 3-door wardrobe with a linen cupboard, a dressing area and two shelves.
- A dressing room with rod and 2 shelves
- 2-drawer chest with niche and 2 shelves



3500L290 : L95 x H84 x P205cm,
Weight : 29 kg - Volume : 0,056m³,
Number of packages : 3



3500DRES : L91 x H123 x P40cm,
Weight : 23 kg - Volume : 0,050m³,
Number of packages : 1



3500AR3P : L135 x H200 x P54cm,
Weight : 93 kg - Volume : 0,18m³,
Number of packages : 3



3500CO2T : L91 x H83 x P40cm, Weight :
28 kg - Volume : 0,059m³, Number of
packages : 1



3500CH1T : L44 x H56 x P33cm,
Weight : 8 kg - Volume : 0,019m³,
Number of packages : 1

KID BEDROOM / Achille



✦ Combine function and industrial style in an ergonomic ACHILLE bed.

✦ This 120x200cm sleeping solution can be adapted in 120x190cm and includes 2 large drawers and open niches, perfect for storing your essentials.

✦ An industrial style in a two-tone **Jackson Oak** with **Black Stipple** niches and handles. Its straight, clean lines make this bed a timeless piece for all ages!



JACKSON OAK

BLACK STIPPLE

The products are made on particleboard with a thickness of 15 and 22 mm

The drawers are equipped with a roller runner system

KID BEDROOM / Achille



The industrial ACHILLE bed includes :

- A 120x200 cm sleeping area that can be adapted to 120x190cm.
- 2 large open niches
- 2 drawers
- 2 Black handles

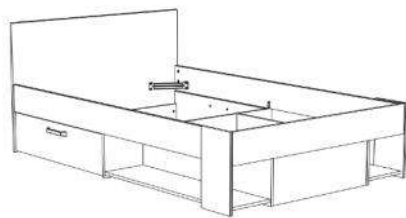

3301L220 : L124 x H77 x P204cm

Weight : 50 kg - Volume : 0,137m³

Number of packages : 2

KID BEDROOM / Alexandra



✦ Unique, innovative and stylish, discover our new take on the bunk bed with our revolutionary **ALEXANDRA** double corner bed solution!

✦ Our corner bunk bed has two spacious desks under each berth, giving each child their own study area. The built-in shelves and desk top add practicality by providing clever storage space. Your children will be able to easily organise their books, school supplies and personal items, fostering a tidy mind and an atmosphere conducive to concentration.

✦ Alexandra is a clever storage solution, with its built-in linen cupboard offering ideal space for storing clothes or toys without cluttering up the bedroom. Thanks to its angled design, this bunk bed creates an ideal bedside table for placing an alarm clock or mobile phone.

✦ The combination of the colours **Japanese Oak** and **White** gives Alexandra a soft, modern aesthetic that lightens the look of this sturdy piece of furniture. The combination of the natural tones of the oak and the freshness of the white creates a bright, warm atmosphere, suitable for both boys and girls.



*The product is made in particle board with a thickness of 15 et 22 mm
The drawers are fitted with ball bearing slides.*

JAPAN OAK

WHITE



The ALEXANDRA double high sleeper includes:

- 2 beds 90x200 cm with integrated slatted bases
- Bedside area
- 2 desks under each bed
- 6 shelves
- A linen cupboard closed by a door



2101LSUR : L296 x H180 x D232cm;
Weight : 222 kg - Volume :
0,465m³; Number of packages : 7

KID BEDROOM / Bibliobed



✦ A bunk bed with two more distinct sleeping areas than a conventional bunk bed

✦ A shaped ladder with **large, non-slip steps** for easy and safe access to the top bunk

✦ An integrated **two-level layout** with open storage space under the staircase and two large platforms next to the sleeping areas that can be used as bedside cabinets or bookcases



WHITE

JACKSON OAK

The products are made of particleboards with a thickness of 15 and 22 mm

KID BEDROOM / Bibliobed



The **BIBLIOBED** bunk bed includes :

- Two bunk beds with dimensions of 90x200 cm including bed bases and accessible via a ladder with three large non-slip steps
- An extra pull-out bed available as an option
- An open storage space located under the staircase and accessible from either side of it
- Two 2-meters long laying platforms with 3 storage compartments each, located next to the two sleeping areas

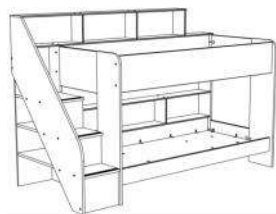

2332LISU : L245 x H171 x D111
Weight : 167 kg - Volume : 0.335m³
Number of packages : 5

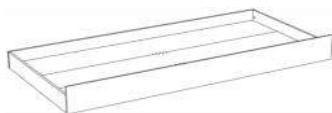

2332TILI : L199 x H19 x D95
Weight : 24 kg - Volume : 0.055m³

KID BEDROOM / Charly



✚ Enjoy a lot of storage space with the Charly collection made of beautiful **Light Acacia | White** furniture with a silver-grey decoprint that is both decorative and recreational

✚ A complete room available at a low price and offering different beds:

- A combined bed
- A low bed
- Two functional beds with step and drawer on wheels! (90x190 cm and 90x200 cm)



The products are made of particleboards with a thickness of 15 and 22 mm

The drawers are equipped with a roller runner system (chest of drawers, 3-door wardrobe) or a ball bearing runner system (desk, bedside table)

LIGHT ACACIA

WHITE

KID BEDROOM / Charly



The mixed bedroom **CHARLY** includes :

- A functional bed with step and drawer available in 90x190 cm and 90x200 cm
- A 90x190 cm low bed and a 90x200 cm combined bed
- A reversible assembly environment
- A desk with a drawer
- A chest of drawers composed of 3 drawers
- A bedside table with a drawer
- A two-door wardrobe with a top shelf and a hanging bar
- An other three-door wardrobe with a hanging bar and a drawer



2498LITM : L121 x H67 x D193 |
Weight : 31 kg - Volume : 0.064m3 |
Number of packages : 2

2498L2TM : L121 x H67 x D203 |
Weight : 32 kg - Volume : 0.064m3 |
Number of packages : 2



2498A2PT : L85 x H180 x D52
Weight : 63 kg - Volume : 0,134m3
Number of packages : 2



2498A3PX : L112 x H180 x D52
Weight : 73 kg - Volume : 0,149m3
Number of packages : 2



2498CH1T : L44 x H40 x D28
Weight : 7 kg - Volume : 0,018m3



2498COMB : L206 x H110 x D183
Weight : 104 kg - Volume : 0,227m3
Number of packages : 4

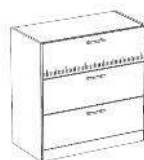

2498CO3T : L78 x H82 x D40
Weight : 25 kg - Volume : 0,052m3



2498BURE : L109 x H75 x D59
Weight : 22 kg - Volume : 0,048m3



2498ENVI : L123 x H93 x D29
Weight : 19 kg - Volume : 0,045m3

KID BEDROOM / Cleo



✦ Discover the Cleo mid sleeper, the ideal functional sleeping solution for your child !

✦ Cleo includes a fixed desk that provides a functional workspace thanks to its niche. At the end of the bed, this desk with its rounded top can also be used as a work space. Cleo has storage units that close with doors, so you can keep your bedroom organised with everything within easy reach.

✦ The central niche has a shelf that acts as a step, making it easy to access the bed, with its cut-out shape that's both attractive and practical.

✦ With its bedside table and hook for hanging clothes or headphones, this timelessly stylish bed combines all the essential elements of a child's bedroom. Its warm White and Japanese Oak colours will brighten up all your decorating styles in both boys' and girls' bedrooms.



WHITE

JAPANESE OAK

The products are made in particleboard with a thickness of 15 and 22mm

KID BEDROOM / Cleo



CLEO midsleeper includes :

- One 90x200 cm bed adaptable in 90x190cm
- A large top as bedside table
- 4 doors for closed storages
- An hook
- One desk with a niche



2103LIBU : L116 x H90 x P240cm,
Weight : 60kg; Volume : 0.129 ; Number
of packages 2

KID BEDROOM / Escale



✦ Did you like the adult Escale range ? Discover the kid's version !

✦ The Escale bed adapts to your room thanks to its shelves, which can be assembled on the left or right handside of the bed. This way, you can dress up your wall with its headboard and these shelves that serve as bedside table. Add optional drawers to optimise your storage space.

✦ Its 3-door wardrobe has an inside mirror and a reversible **Oak** or **White** vertical panel. Complete your storage space with its harmonious 1-door 3-drawer chest. Now escale presents an office for your child's revision and hobbies.

✦ The Escale range is inspired by the Japandi trend, with a worked design. This bedroom features hand-grip handles and discreet decorative mouldings. The **Japanese Oak** colour will give your kid's bedroom a warm, harmonious and trendy feel.



JAPANESE OAK



The products are made from 15 and 22 mm thick particleboard.

The chest drawers are fitted with a roller runner system



The ESCALE bedroom includes

- A 90x190-200cm bed with a headboard with shelves used as a bedside table
- A set of two 51 cm deep drawers available as an option
- A desk with 1 drawer and 2 open niches. The claustra-style credenza has 3 shelves
- A chest of 3 drawers and a door
- A 3-door wardrobe including 1/3 shelving part (3 shelves) and 2/3 hanging part and inside mirror.



3580L290 : L122 x H89 x P217;
Weight : 38kg - Volume : 0,081m3;
Number of packages : 2

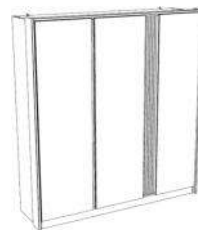

3580AR5C : L185 x H203 x P52;
Weight : 132 kg - Volume :
0,276m3; Number of packages : 5

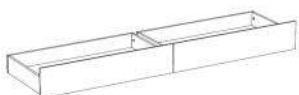

3580T2RO : L199 x H22 x P51;
Weight : 13 kg - Volume : 0,031m3;
Number of packages : 1



3580COPT : L110 x H77 x P50.
Weight : 42 kg - Volume :
0,084m3. Number of packages : 2



3580BURE : L138 x H121 x P58;
Weight : 39 kg - Volume : 0,079m3;
Number of packages : 2

KID BEDROOM / Fabric



✦ A clever and functional collection including beautiful furniture with **large storage volumes**, including a bed with a drawer at the front (plus an optional set of two side drawers), a bedside table with a reversible door and a desk with extension equipped with closed storage compartments

✦ With its steel handles and its decoprint impression, this "urban" style bedroom is perfect for pre-teens who want to assert their character



The products are made of particleboard with a thickness of 12,15 and 22 mm
 The drawers are equipped with a roller runner system (ball-bearing for the bedside table)

DARK GREY

LOFT GREY



The urban style bedroom **FABRIC** includes :

- A bed with a large 48 cm deep drawer at the front (plus an optional set of two side drawers)
- A 2-door wardrobe with two 48 cm deep open storage spaces
- A desk with extension equipped with a drawer, a closed storage compartment and a 24 cm deep platform
- A chest of drawers with three 35 cm deep drawers
- A bedside table with a drawer including a reversible door



2311L2TI : L99 x H66 x D207
Weight : 31 kg - Volume : 0,065m³
Number of packages : 2



2311T2CO : L149 x H18 x D42
Weight : 14 kg - Volume : 0,038m³



2311BURE : L108 x H114 x D56
Weight : 29 kg - Volume : 0,06m³



2311CHEV : L40 x H45 x D28
Weight : 8 kg - Volume : 0,017m³



2311CO3T : L87 x H76 x D40
Weight : 28 kg - Volume : 0,058m³



2311AR2P : L101 x H182 x D51
Weight : 65 kg - Volume : 0,126m³
Number of packages : 2

KID BEDROOM / Finland



✦ A functional mixed combined bed in two-tone **White | Jackson Oak** for a natural style, suitable for both boys and girls

✦ Rounded ladder with ABS edges and two widened steps of 17 and 18 cm depth for optimal comfort of use

✦ A **space-saving solution**, with a bed placed at half height overhanging many storage compartments to optimize the available space



WHITE

JACKSON OAK

The products are made of particleboards with a thickness of 15 and 22 mm.

KID BEDROOM / Finland



The **FINLAND** combined bed includes :

- A 90x200 cm bed, halfway up and accessible via a ladder with two steps
- A storage space made up of four 35-cm-deep compartments
- A 90x65 cm removable desk with two storage compartments sized L:60 x H:33 cm
- A storage space at the bottom of the bed sized L:93 x W:40 cm

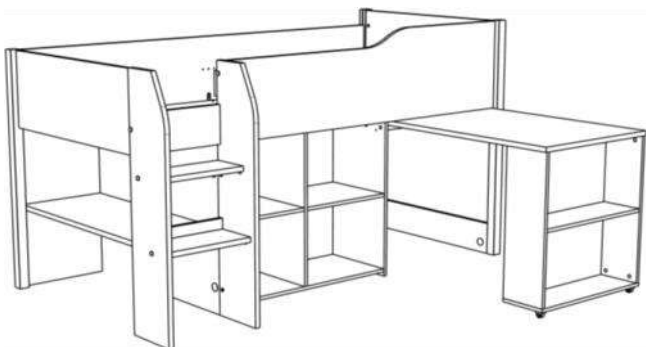

2530COMB : L209 x H118 x D183
Weight : 114 kg - Volume : 0.270m³
Number of packages : 5

KID BEDROOM / GRAYSON



A space for your child!

✦ Combining the functions of bed, wardrobe and desk, this high sleeper with its numerous storage spaces is ideal for creating a space where your child can grow freely.

✦ Choose your atmosphere with this functional and decorative masterpiece. Go for an industrial and retro style with the **Artisan Oak | Dark Grey**.



DARK GREY

ARTISAN OAK

*The products are made of particle board, with a thickness of 15 and 22 mm
The drawers are equipped with a metal runner system with rollers*

KID BEDROOM / GRAYSON



The GRAYSON high sleeper includes :

- A 90x200 cm bed with a bed base and access via a four-step ladder
- A 130 cm long x 57 cm deep desk located under the bed and equipped with a drawer and a hutch.
- A closed cupboard-type storage space with shelves and a hanging rail
- A 160 cm long shelf located at the top and acting as a bedside



2380LSUR : L204 x H178 x P116 ;
Poids : 141 kg - Volume : 0.295m3;
Number of packages: 5

KID BERDOOM / HIGHER



✦ An integrated **two-level layout** with a closed storage space including a closet rod, a desk, two platforms and multiple storage compartments

✦ A sturdy product with a quality finish, thick edges and shaped parts with a thickness of 28 mm

✦ A 5-step ladder that allows easy and safe access to the top bunk



The products are made of particleboards with a thickness of 15 and 28 mm
The closed storage space is equipped with a roller runner system



The mezzanine bed **HIGHER** includes :

- A 90x200 cm sleeping area accessible through a 5-step ladder
- A desk of L133 x P66 cm under the bed
- Three L87 x D20 cm shelves providing numerous storage niches under the bed
- A closed storage space similar to a wardrobe equipped with a sliding door and including a closet rod
- One platform of W160 x D23 cm on the outside of the bed and another of W200 x D23 cm on the inside, above 2 additional storage niches



2410LSU2 : L206 x H189 x D138
Weight : 184 kg - Volume : 0.387m³
Number of packages : 7

KID BEDROOM / Jade



✦ The Jade all-in-one bed has plenty of storage space thanks to two chest-style doors, a bookcase area above, a desk measuring W100 x D39 cm that doubles as a bedside table, and over 900 litres of storage space under the bed.

✦ Available in modern **Japanese Oak** | **Celadon Green**, this bed highlights the design lines of this mixed model, perfect for both boys' and girls' homes.



*The products are made in particle board with a thickness of 15 and 22 mm
The drawers are equipped with a system of roller runner*

JACKSON OAK

CELADON GREEN



The **JADE** bed includes :

- A bed measuring 90x200 cm, adaptable to 90x190 cm, set at half-height
- Two doors with wooden knob handles and a storage niche.
- A desk area measuring W100 x D39 cm.
- Over 900 litres of storage space under the bed.
- A bookcase area measuring 75 cm above the doors and niche, extending from the desk.



2180LIBU : L134 x H90 x D203cm,
Weight : 48kg; Volume : 0.119m³;
Number of packages : 2

KID BEDROOM / Leo



✦ Discover Leo, a bunk bed with built-in bedside tables !

✦ A two-level layout including bed bases, two storage areas, each with 3 niches (W67 x H27 cm) that are perfect as bedside units, and a platform (W207 cm) on each level. Leo is accessible via a 3-step ladder.

✦ This bunk bed can be fitted with an optional drawer on castors.

✦ Leo is available in **Jackson Oak | Shadow Grey** and **Brooklyn Oak | White**. The natural version incorporates reversible niche backs that can be fitted in the same decors.



*The products are made of particleboards with a thickness of 15, 18 and 22 mm.
The optional trundle bed is equipped with a roller runner system.*

DARK GREY

JACKSON OAK

WHITE

BROOKLYN OAK



The LEO customisable bunk bed includes :

- Two bunk beds with 90x200 cm base accessible via a three-step ladder
- Optional drawer W163 x D42 cm
- A storage area comprising three niches (W67 x H27 cm) and a platform (W207 cm) on each level, which doubles as a bedside table.
- Reversible **White | Oak** niche backs supplied with the White version of the LEO model

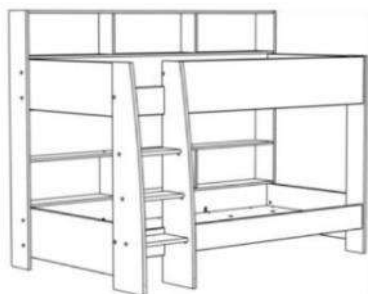

L207 x H164 x D132cm (**2344 & 2544**) Weight : 130 kg - Volume : 0.274m³ (2744) Weight : 121 kg - Volume : 0.253m³, Number of packages : 5

2544LIS4 : White + White | Brooklyn Oak reversible shelves

2744LISU : Jackson Oak | Dark Grey + Dark Grey shelves



L163 x H22 x P42, Weight : 10 kg - Volume : 0.022m³

2344TIRO : White

KID BEDROOM / Lucas



✦ Discover our Lucas mid sleeper : the top-of-the-range, multifunctional and complete bed designed to give maximum comfort while optimizing space.

✦ Lucas includes its own workspace with a functional desk that slides under the bed after use. The niches are ideal for storing books. When the desk is closed, the niches align to create a uniform, harmonious front.

✦ To complete the function, a storage space is hidden behind the ladder, contrasting with the work space. Store toys or offer your child a spacious hiding place thanks to the free space under the bed.

✦ A shaped ladder provides access to the bed, with storage shelf and 3 niches as bedside tables. The **Japanese Oak** structural parts recall the robustness of wood, while the **White** elements create an elegant, contemporary two-tone look that will suit boys and girls alike.



The products are made in particleboard, with a thickness of 15 et 22 mm

JAPANESE OAK

WHITE



LUCAS mid sleeper includes :

- 1 desk with wheel that stores under the bed
- 9 storage niches
- A storage shelf above the niches as bedside tables
- A shaped ladder with 2 steps



2100COMB : L207 x H164 x P132x;
Weight : 123kg - Volume :
0.274m³; Number of packages : 5

KID BEDROOM / Milky



✦ The **Milky** all-in-one bed has plenty of storage spaces including two drawers, a bookcase area, a L100 x D39 cm desk and over **900 liters** of storage space under the

✦ Available in its two modern versions **Jackson Oak | Black Stipple** or **White | Loft Grey** enhancing the lines of this unisex model to make it the central element of both a boy's and girl's room



The products are made of particleboards with a thickness of 15 and 22 mm. The optional trundle bed is equipped with a roller runner system.

| | |
|-----------|---------------|
| WHITE | JACKSON OAK |
| LOFT GREY | BLACK STIPPLE |

KID BEDROOM / Milky



The MILKY all-in-one bed includes :

- A 90x200 cm halfway up bed, adaptable to 90x190 cm, accessible via a two-step ladder
- Two L75 x D35 cm drawers with slim, trendy and ergonomic handles
- A L100 x D39 cm desk
- Over 900 liters of storage space under the bed
- A L75 cm bookshelf space above the drawers as an extension of the desk

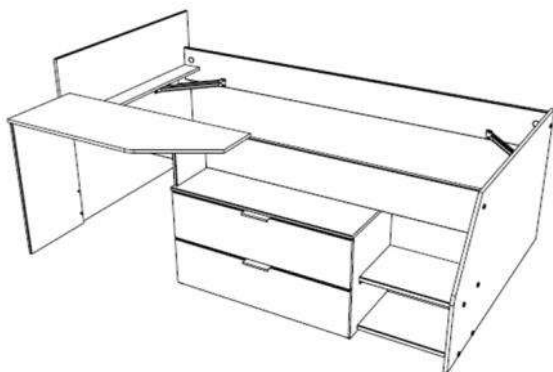

Dimensions : L134 x H90 x D203
Weight : 62 kg - Volume : 0.143m³ (2389) - 0.131m³ (2309)
Number of packages : 2

2389LITI : Jackson Oak | Black Stipple version
2309LITI : White | Loft Grey version

KID BEDROOM / Nashville



✚ Available in 90x200cm, the Nashville bed has multiple storage spaces with two drawers and a shelf, which can be placed on the right or left side of the bed according to your wishes

✚ Match your Nashville industrial bed with the chest of drawers and bedside table in the same colour!

✚ The black metal effect of the handles matches the **Black Stipple** moulding for a trendy two-tone **Black Stipple | Jackson Oak** look. This model is also available in a more traditional **White | Silver Grey** two-tone look



*The products are made of particleboards with a thickness of 15 and 22 mm
The drawers are equipped with a ball-bearing runner system*

| | |
|-------------|---------------|
| WHITE | JACKSON OAK |
| SILVER GREY | BLACK STIPPLE |

KID BEDROOM / Nashville



The NASHVILLE bed includes :

- One bed available in 90x200
- Two L66 x D33 cm removable drawers with slim and trendy black metal effect handles that can be placed on the right or left side of the Bed
- A chest of 3 drawers and bedside table with one drawer
- A headboard with a Black Stipple molding for the Jackson Oak models or Silver Grey for the White models
- An additional storage space placed between the drawers

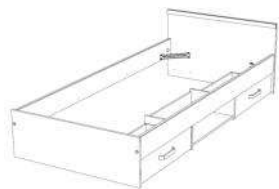

Sizes : L96 x H59 x P203, Weight : 30 kg -
Volume : 0.063m³, Number of packages : 2

2038L2TI : White | Silver Grey

2078L2TI : Jackson Oak | Black Stipple



2078CO3T : L80 x H88 x P44

Weight : 30 kg - Volume : 0.064m³

Number of packages : 1



2078CH1T : L40 x H34 x P30

Weight : 7 kg - Volume : 0.017m³

Number of packages : 1



A whole new universe at your fingertips !

✚ In addition to its large desk with a shelf that can accommodate 3 screens, this elevated bed in **Black Stipple** has many assets that will allow you to enjoy an immersive and space-saving experience!

✚ This elevated bed also has many features:

- 90 x 200 cm bed
- large 184 x 60 cm desk
- shelf with double USB socket
- drawer with carbon finish handle
- dedicated space for central unit
- RGB LED kit with remote control

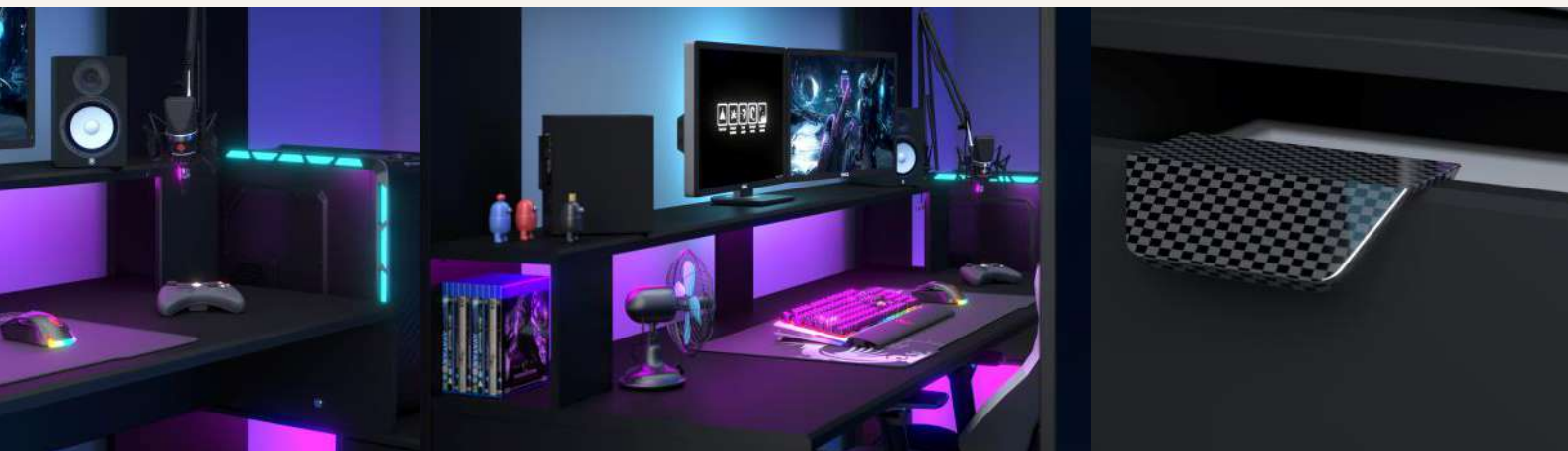

BLACK STIPPLE

The products are made of particleboards with a thickness of 15 and 22 mm
The drawer is equipped with a roller runner system

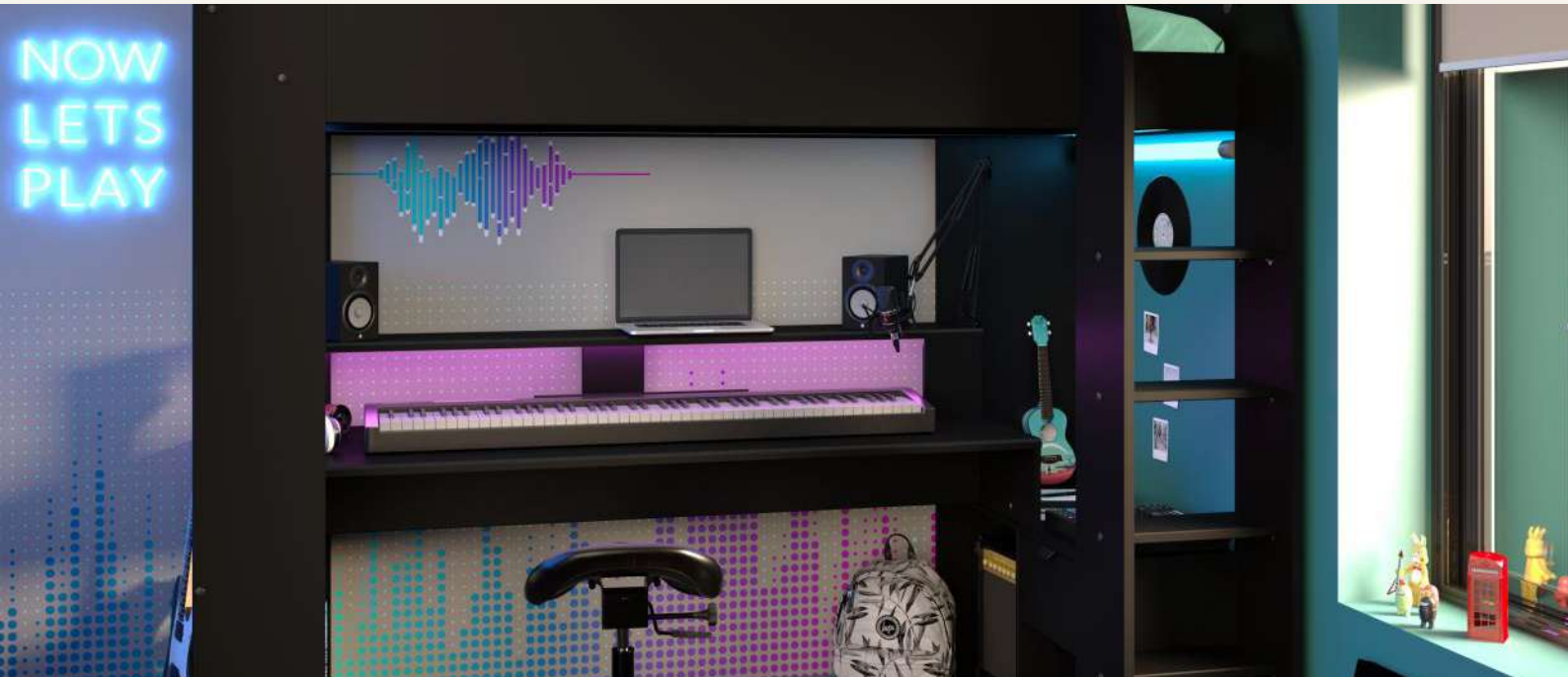

The elevated bed **ONLINE** includes :

- A bed with dimensions of 90x200 cm accessible via a four-step ladder
- A 184 cm long x 60 cm deep desk with a shelf that can accommodate 3 screens
- A bedside platform with double USB socket
- A dedicated space for a central unit, above open storage compartments
- An easily accessible drawer with carbon finish handle
- A RGB LED kit with remote control included
- An additional 90 cm long platform to the left of the desk

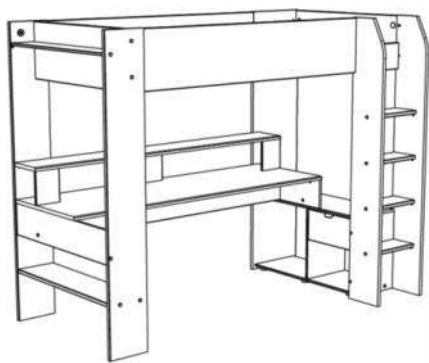

2368LSUR : L220 x H180 x D116
Weight : 133 kg - Volume : 0.275m³
Number of packages : 5

KID BEDROOM / Pirouette



✦ Pirouette is a complete room that will adapt to your child and his needs. This unisex room includes a low bed and a midsleeper, a desk, a bedside table, a chest of drawers and a wardrobe.

✦ Its **White** colour and its reversible panels in **Pebble Grey** or **Pink** can be adapted to your child's taste during assembly. Pirouette is a timeless range that will be the best ally of children and parents.



The products are made of particleboard, with a thickness of 15 mm

WHITE

PEBBLE GREY

PINK

KID BEDROOM / Pirouette

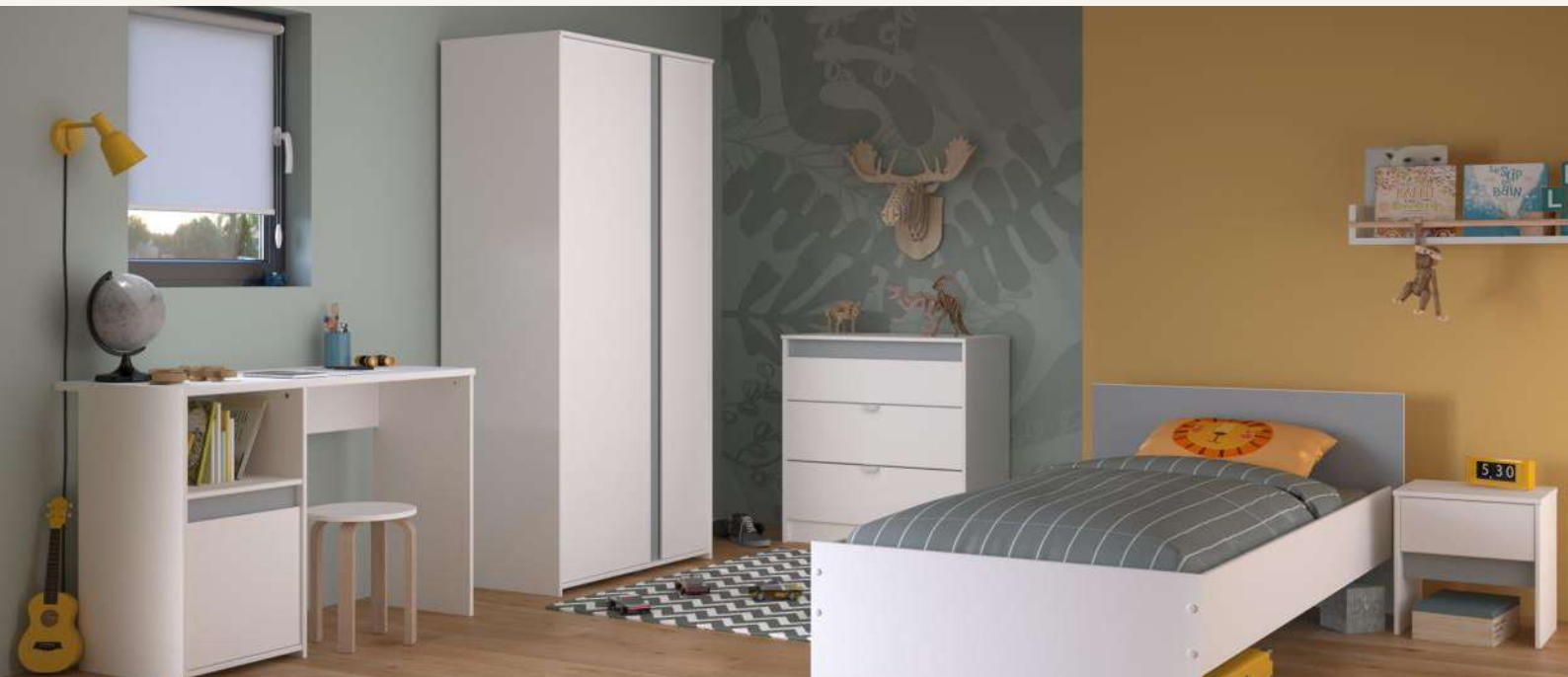

The timeless **PIROUETTE** room includes :

- 2 beds including a 90cm low bed and a misleper with storage and a large rounded desk top.
- A chest with 3 spacious drawers.
- A bedside table with a drawer.
- 1 cupboard of 1.82m with 2 doors and an inside comprising 3 shelves and 2 hanging rails.
- A desk with a door and a niche.



2150COMB : L. : 204 cm - H. : 104 cm - P. 132 ; Weight : 91 ; Volume : 0.187m³ ; Number of packages : 4



2150LI90 : L. : 100 cm - H. : 67 cm - P. : 193 cm ; Weight : 21 ; Volume : 0.055m³ ; Number of packages : 1



2150L290 : L. : 100 cm - H. : 67 cm - P. : 203 cm ; Weight : 21 ; Volume : 0.056m³ ; Number of packages : 1



2150CO3T : L. : 83 cm - H. : 82 cm - P. : 43 cm ; Weight : 26 ; Volume : 0.053m³ ; Number of packages : 1

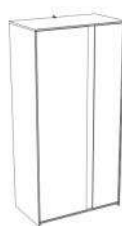

2150AR2P : L. : 91 cm - H. : 182 cm - P. : 50 cm ; Weight : 62 ; Volume : 0.123m³ ; Number of packages : 2



2150BU1P : L. : 110 cm - H. : 75 cm - P. : 50 cm ; Weight : 24 ; Volume : 0.053m³ ; Number of packages : 1



2150CH1T : L. : 33 cm - H. : 40 cm - P. : 33 cm ; Weight : 7 ; Volume : 0.014m³ ; Number of packages : 1

KID BEDROOM / Pirouette



✚ Furnish your boy's or girl's bedroom with our functional and space-saving sleeping solution: the Pirouette mid sleeper !

✚ To store your child's toys or notebooks, Pirouette offers 4 storage niches on which rests a long rounded desk top creating a compact and practical work space. As for your bulky items, they will perfectly find their place in the large space located under the bed where your child will love to hide!

✚ This mid sleeper bed, accessible by 2 steps, stands out thanks to its timeless White colour enhanced by its reversible Pebble Grey or Pink panels.

Its minimalist design and rounded finishes make Pirouette a must-have for mid sleeper beds.



WHITE

PINK

PEBBLE GREY

The products are made of particleboard, with a thickness of 15, 18 and 22 mm

KID BEDROOM / Pirouette



The PIROUETTE combined bed includes:

- A 1m high bed accessible by 2 steps
- A 160cm long desk
- Designed to accommodate a 90x190cm or 90x200cm mattress
- 4 niches of 25cm depth with reversible shelves

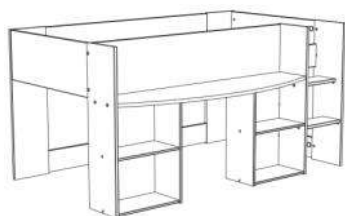

2150COMB : L. : 204 cm - H. : 104 cm - P. : 131; weight : 91kg; Volume : 0.187; Number of packages : 4

KID BEDROOM / Reverse



✦ A combined bed at a low price including :

- A 90x200 cm bed, halfway up and accessible via a ladder with two steps
- A removable desk of 89x67 cm
- A storage compartment closed by two doors and a 38 cm deep open storage compartment above

✦ A timeless **White** decoration enhanced by the presence of **Silver Grey** mouldings at the head and foot of the bed for a very contemporary look!



2270COMB : L206 x H110 x D183
 Weight : 101 kg - Volume : 0,212m3
 Number of packages : 2

The products are made of particleboards with a thickness of 16 and 22 mm

WHITE

SILVER GREY



✦ Let your imagination run wild and design your room like a tree house with the Shelter collection in **Jackson Oak | White** tones

- ✦ A complete bedroom with :
- Two low beds (90x190 cm and 90x200 cm)
 - A bed environment or desk
 - A cot and changing table
 - A 2-door wardrobe
 - A chest of drawers
 - One bedside table
 - A desk



JACKSON OAK

WHITE

*The products are made of particleboards with a thickness of 15 and 22 mm
The drawers are equipped with a roller runner system (ball bearing for the office and the environment)*



The SHELTER cabin themed bedroom includes :

- A low bed available in 90x190 cm and 90x200 cm, plus an optional set of 2 drawers
- A wardrobe with 2 doors and a drawer
- A desk with drawer
- A two-drawer chest with two storage niches
- An environment that can be arranged either around the bed or the desk
- 1-door bedside cabinet
- A cot and changing table



2400LI90 : L98 x H66 x P194cm;
Weight : 20kg - Volume :
0,043m³; Number of packages : 2



2400L290 : L98 x H66 x P203cm;
Weight : 21kg - Volume :
0,047m³; Number of packages : 2

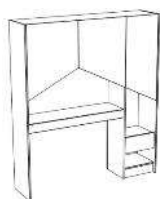

2400ENVI : L132 x H151 x P32cm;
Weight : 43kg - Volume :
0,094m³; Number of packages : 2



2400TIRO : L189 x H21 x P42cm;
Weight : 12kg - Volume :
0,024m³; Number of packages : 1

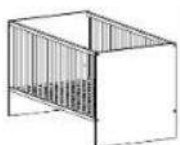

2400LIBB : L124 x H86 x P66cm;
Weight : 22kg - Volume :
0,096m³; Number of packages : 1

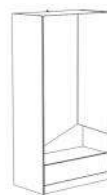

2400A2PT : L92 x H181 x P50cm;
Weight : 61kg - Volume :
0,127m³; Number of packages : 2



2400CO2T : L84 x H78 x P40cm;
Weight : 26kg - Volume :
0,056m³; Number of packages : 1



2400CH1P : L40 x H41 x P33cm;
Weight : 7kg - Volume : 0,019m³;
Number of packages : 1



2400BURE : L94 x H71 x P50cm;
Weight : 16kg - Volume :
0,037m³; Number of packages : 1



2400PLAN : L55 x H20 x P77cm;
Weight : 7kg - Volume : 0,018m³;
Number of packages : 1

KID BEDROOM / Shelter



✦ The Shelter range is extending with its bunkbed !

✦ A space-saving bunkbed including a base, niches and shelves are a great feature acting as the equivalent of a bedside table. Its rounded ladder guarantees easy and safe access to the top bunk.

✦ An optional large storage drawer can be added to optimise the space under the bed.

✦ The Shelter bunkbed will perfectly fit with the other items of the range, creating a unique universe for girls and boys with its natural White and Jackson Oak colours.



JACKSON OAK

WHITE

The products are made in particle board with a thickness of 15 and 22 mm

The drawers are equipped with a roller runner system

KID BEDROOM / Shelter



SHELTER bunked includes :

- Two 90x200 cm beds
- A ladder with 3 steps
- 1 base, 3 niches and shelves acting as the equivalent of a bedside table
- L163xP42cm drawer in option



2400LISU : L207 x H164 x P132
Weight : 121 kg - Volume : 0,253m3
Number of packages : 5



2400TIR2 : L163 x H22 x P42
Weight : 10 kg - Volume : 0,022m3
Number of packages : 1

KID BEDROOM / Shelter



✚ Looking for an innovative solution to optimize space in your kid's bedroom without compromising aesthetics and functionality ? Our high-sleeper SHELTER is the perfect answer to your needs.

✚ The smart design of Shelter is ideal for rooms with limited space as it combines sleeping, workspace and storage. This bed includes a desk with drawer, a wardrobe, and a spacious shelf to store your items, notebooks or clothing.

✚ Its rounded ladder gives an easy access to its functional 90x200cm sleeping space, the 3 compartments covered with the top shelf offer large bedside space.

✚ The harmonious fusion of warm **Jackson Oak** and **White** creates a polyvalent design, that adapts to the tastes of both girls and boys. For a perfect match, mix your high-sleeper with other elements from the SHELTER range.



JACKSON OAK

WHITE

The products are made of particleboard, with a thickness of 15 et 22 mm

Drawers are equipped with a roller runner system

KID BEDROOM / Shelter



The SHELTER high sleeper includes :

- One 90x200cm bed accessible via a 4-step ladder
- One bed base, 3 niches and a top shelf
- A spacious shelf
- A desk with 1 drawer
- Bookcase with 3 shelves
- A closet

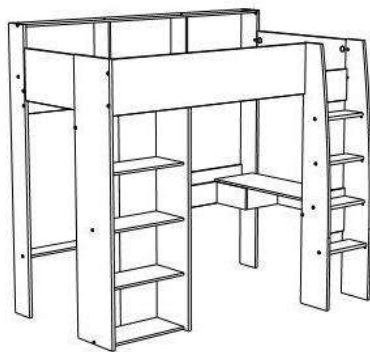

2400LSUR : L204 x H193 x P132cm;
Weight : 119 kg - Volume : 0,246m3;
Number of packages : 5

KID BEDROOM / Shelter



✚ Our **Shelter** range is constantly reinventing itself and now presents its new combined bed.

✚ As well as a 90x200cm bed, the combined bed has a large work area. The ladder separates the sleeping area from the work area. The side storage compartments are perfect for keeping notebooks, files or even clothes.

✚ The Shelter mid-sleeper bed will perfectly match the other elements of the range, creating a unique universe for girls and boys thanks to its natural and mixed **White** and **Jackson Oak** colours.



JACKSON OAK

WHITE

The products are made un partcile boards with a thickness of 15 and 22mm

KID BEDROOM / Shelter



The new **SHELTER** midsleeper includes :

- A 90x200cm bed
- A fixed 42 x 135 mm work surface for easy access to the ladder and movement around the room
- A scale with 2 steps
- A side shelf for magazines

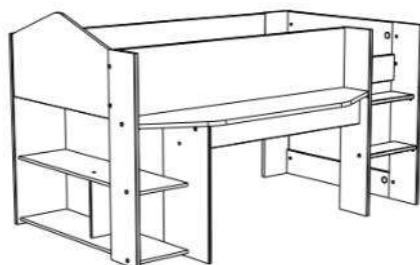

2400COM2 : L205 x H120 x D134cm;
Weight : 89 kg - Volume : 0,185m³
Number of packages : 3

KID BEDROOM / Shelter Celadon



✚ The SHELTER CELADON collection transforms your child's bedroom into a real space for play and rest, inspired by the world of tree houses.

✚ Shelter includes a lot of storage solutions to keep your child's bedroom tidy with its 2-door wardrobe and built-in drawer perfect for organising clothes and accessories, while the 2-drawer chest and storage niches are ideal for toys, books and other small items. Use the space under the bed for extra clutter-free storage.

✚ The headboard can be arranged around the 90x190cm or 90x200 bed as a bedside cabinet. If you prefer to add it to the desk to optimise storage, you can add a single bedside door to your bed.

✚ The harmonious fusion of warm **Jackson Oak** and **Celadon Green** gives the sleeping area a lively feel and plunges you into a natural world completed by the cabin style. Soft and trendy, SHELTER CELADON is just as suitable for a girl as it is for a boy!



JACKSON OAK

CELADON GREEN

The products are made in particleboard with a thickness of 15 and 22 mm

The drawers are equipped with a roller runner systems



The **SHELTER CELADON** range includes :

- A bed available in 90x190 cm and 90x200 cm, plus an optional set of 2 drawers
- A wardrobe with 2 doors and a drawer
- A desk with drawer
- A two-drawer chest of drawers with two storage niches
- An headboard that can be arranged either around the bed or the desk
- 1-door bedside cabinet

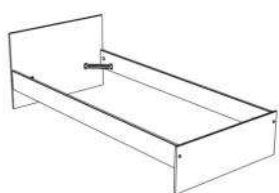

2400LI90 : L98 x H66 x P194cm;
Weight : 20kg - Volume : 0,043m³; Number of packages : 2



2400L290 : L98 x H66 x P203cm;
Weight : 21kg - Volume : 0,047m³; Number of packages : 2

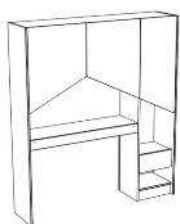

2401ENVI : L132 x H151 x P32cm;
Weight : 43kg - Volume : 0,094m³; Number of packages : 2



2401TIRO : L189 x H21 x P42cm;
Weight : 12kg - Volume : 0,024m³; Number of packages : 1

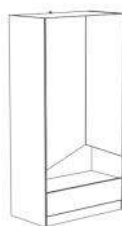

2401A2PT : L92 x H181 x P50cm;
Weight : 61kg - Volume : 0,127m³; Number of packages : 2



2401CO2T : L84 x H78 x P40cm;
Weight : 26kg - Volume : 0,056m³; Number of packages : 1



2401CO2T : L40 x H41 x P33cm;
Weight : 7kg - Volume : 0,019m³; Number of packages : 1



2400BURE : L94 x H71 x P50cm;
Weight : 16kg - Volume : 0,037m³; Number of packages : 1

KID BEDROOM / Sleep



- ✦ The compact, design Sleep day bed has been updated with new, trendy, mixed colours !
- ✦ No need of bedside table, thanks to its 3 niches and 2m of storage shelf, so you can keep everything within easy reach. To optimise storage without requiring more space in your bedroom, add our option of 2 large drawers under your bed, available in two colours.

✦ During assembly, Sleep will adapt to your tastes by offering you **White** or **Japanese Oak** niche back panels. The colours of this modern bed with its rounded shapes will look just as good in a girl bedroom as in a boy bedroom.



WHITE

JAPANESE OAK

The products are made in particleboard with a thickness of 15 mm.

KID BEDROOM / Sleep



The **SLEEP** day bed includes :

- A 90x190-200 cm bed
- 3 storage niches with either White or Oak back panels
- Set of 2 drawers available in two colours

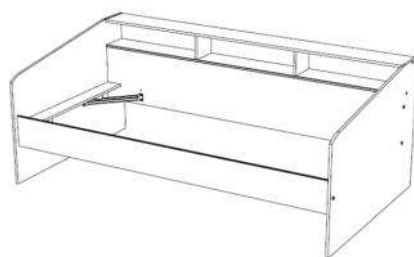

2339L290 : L203 x H82 x P113.
Weight : 48 kg - Volume : 0.104m³
Number of packages : 2

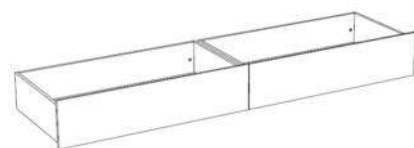

L199 x H25 x P53. Weight : 18 kg -
Volume : 0.041m³; Number of
packages : 1

2339TIRO : Japanese Oak
2338TIRO : White

KID BEDROOM / Smoozy



✚ A complete and **functional** bedroom offering two different sleeping solutions at a low price: a low bed equipped with **large drawers** to store books, toys and much more, or an elevated bed including a desk with a large surface and 3 side shelves

✚ This **Petterson Pine** decor bedroom is equipped with beautiful and ergonomic recessed handles but also with reversible **Blue | Pink** edges for a look that will appeal to both girls and boys!



The products are made of particleboards with a thickness of 15 and 22 mm

The drawers are equipped with a roller runner system (or with a ball-bearing one for the bedside table and the desk)

PETTERSON PINE

BLUE

PINK

KID BEDROOM / Smoozy



The **SMOOZY** bedroom includes :

- A functional bed with two drawers and two storage compartments
- An elevated bed including a desk with a 160 cm long top and 3 side shelves
- A bedside table with a drawer
- A chest of drawers composed of 3 drawers
- A desk with a drawer and a door
- A 182 cm high wardrobe, equipped with 3 shelves and 2 hanging bars



2223L2TI : L95 x H80 x D203
Weight : 52 kg - Volume : 0,106m³
Number of packages : 2



2223LSUR : L206 x H180 x D108
Weight : 111 kg - Volume : 0,226m³
Number of packages : 3



2223BURE : L121 x H77 x D50
Weight : 28 kg - Volume : 0,07m³



2223CH1T : L40 x H41 x D33
Weight : 8 kg - Volume : 0,018m³



2223CO3T : L79 x H75 x D41
Weight : 28 kg - Volume : 0,056m³

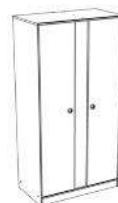

2223A2PR : L90 x H182 x D51
Weight : 63 kg - Volume : 0,129m³
Number of packages : 2

KID BEDROOM / Stim 2



✦ A bunk bed with two more distinct sleeping spaces than a conventional bunk bed

✦ A shaped ladder that allows easy and safe access to the top bed

✦ An integrated two-level layout with a closed storage space including a three-ray shelf, a wardrobe rail, a drawer, a platform of L92 x D16 cm next to the upper bed + a bedside table of L57 x D24 cm behind the lower storage space

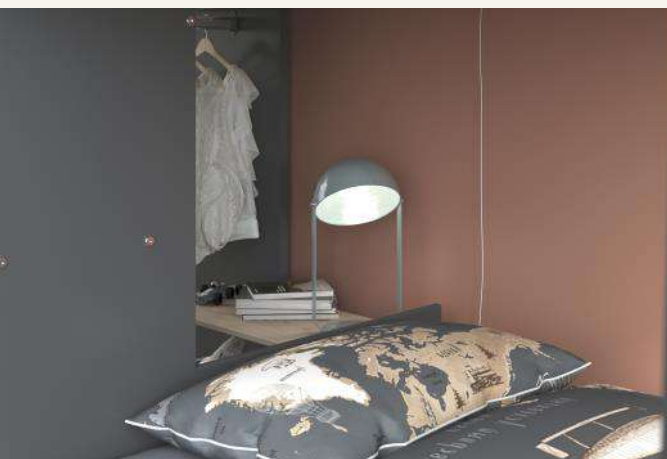

The products are made of particleboards with a thickness of 15 and 22 mm
The drawer is equipped with a roller runner system

DARK GREY

JACKSON OAK



The **STIM 2** bunk bed includes :

- Two bunk beds of 90x200 cm, with bed bases and accessible via a three-step ladder
- One L104 x D39 cm drawer below the bottom bed
- A L57 x D24 cm bedside table behind the lower storage compartment
- A closed storage compartment including a L72 x D37 cm three-level shelf
- A wardrobe rail behind the closed storage compartment, with an integrated shelf
- A platform of L92 x D16 cm at the edge of the upper bed

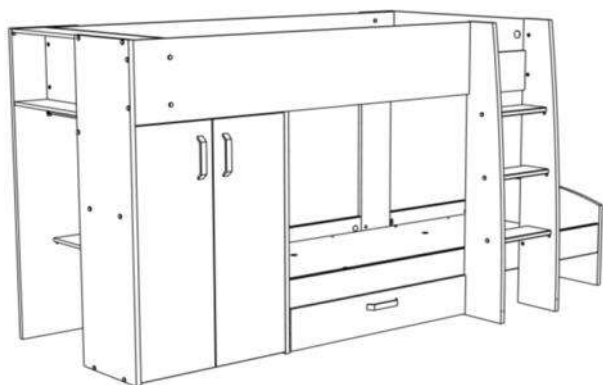

2142LISU : L280 x H142 x D119
Weight : 150 kg - Volume : 0.299m3
Number of packages : 5

KID BEDROOM / Tobo



✦ **Playful and functional**, this half-height bed has extra storage space under the bed with two side drawers equipped with ergonomic handles and an open shelf at the bottom of the bed

✦ The slide ramp is adapted to children and protected by ABS edges to guarantee their safety

✦ A trendy and refined style with the two-tone **White | Jackson Oak** decor that brings a touch of nature



The products are made of particleboards with a thickness of 15 and 22 mm
The drawers are equipped with a roller runner system

WHITE

JACKSON OAK



The TOBO bed-toboggan includes :

- A bed sized 90x200 cm, halfway up, including a bed base and accessible via a two-step ladder
- Two L64 x D35 cm drawers with ergonomic handles
- Two storage spaces of L90 x W30 cm at the bottom of the bed
- A toboggan sized L97 x W35 cm

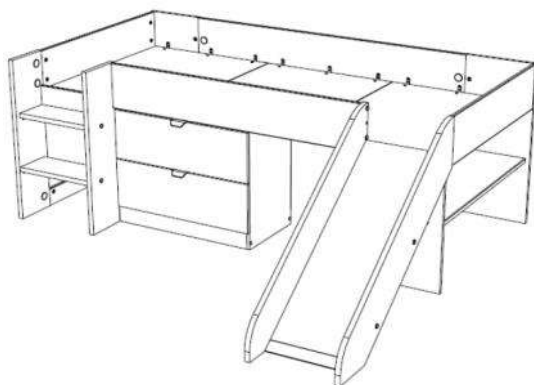

2374TOBO : L204 x H78 x D184
Weight : 83 kg - Volume : 0.185m3
Number of Packages : 3

KID BEDROOM / TOM



✦ A multi-functional combined bed with a sleeping area, a 130 cm long desk with cable management, large storage spaces and a spacious wardrobe

✦ Create a natural and warm atmosphere in your child's room with this **Jackson Oak | White** bed

✦ Easy access to the bed thanks to a shaped passageway and a wide, refocused ladder



JACKSON OAK

WHITE

The products are made of particleboards with a thickness of 15 and 22 mm
The drawers are equipped with a ball-bearing runner system

KID BEDROOM / TOM



The combined bed **TOM** includes :

- A 90x200 cm sleeping area accessible via a four-step ladder
- A large 130 cm long desk with cable management, but also 3 deep drawers for maximum storage capacity
- A spacious closed cupboard-type storage space measuring over 65 cm long x 106 cm high x 40 cm deep and including a shelf and a hanging bar

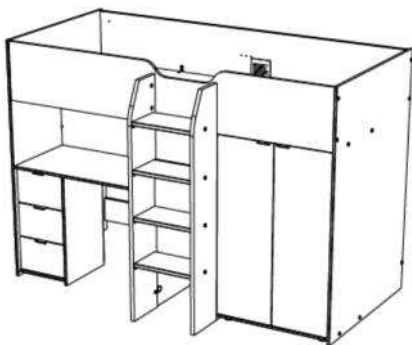

2360COMB : L203 x H146 x D118
Weight : 135 kg - Volume : 0.285m³
Number of packages : 5



ADULT BEDROOMS

KID BEDROOM / Aalborg



✦ The AALBORG adult bedroom has been reinvented with smart new features, while retaining its Nordic-inspired look.

✦ The Aalborg beds available in 140x190 cm, 140x200 cm or 160x200 cm can now be fitted with a console on castors ideal for reading, working or having breakfast.

✦ The range includes clever storage solutions, with a dressing table and chest of drawers that can be stacked to save space, or placed side by side to fit into attics and a 3-door wardrobe.

✦ With its clean lines and compass legs, the Aalborg collection will win you over with its Japanese Oak and White colour combinations. Slim, plain handles subtly dress up the furniture for an elegant, timeless look.



*The products are made in particleboard with the thickness of 12, 15 and 22 mm
The drawers are equipped with a roller runner systems*

WHITE

JAPANESE OAK

KID BEDROOM / Aalborg



The AALBORG Scandinavian bedroom includes:

- A bed available in 140x190 cm, 140x200cm or 160x200 cm with a H84 cm headboard included
- 56 cm high bedside unit with drawer and storage niche
- A sliding console to place above the bed
- A dressing room with rod and 2 shelves
- 2-drawer chest with niche and 2 shelves
- A 3-door wardrobe with a linen cupboard, a dressing area and two drawers



3500L140 : L145 x H84 x P195cm, Weight : 36 kg - Volume : 0,073m3, Number of packages: 3



3500L240 : L145 x H84 x P205cm, Weight : 36 kg - Volume : 0,074m3; Number of packages: 3

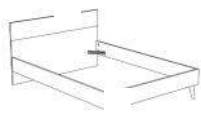

3500L260 : L165 x H84 x P205cm, Weight : 42 kg - Volume : 0,084m3, Number of packages: 4



3500CONS : L167 x H75 x P317cm, Weight : 21 kg - Volume : 0,041m3, Number of packages : 1



3500AR3P : L135 x H200 x P54cm, Weight : 93 kg - Volume : 0,18m3, Number of packages : 3



3500DRES : L91 x H123 x P40cm, Weight : 23 kg - Volume : 0,050m3, Number of packages : 1



3500CO2T : L91 x H83 x P40cm, Weight : 28 kg - Volume : 0,059m3, Number of packages : 1



3500CH1T : L44 x H56 x P33cm, Weight : 8 kg - Volume : 0,019m3, Number of packages : 1

ADULT BEDROOM / Achille



✦ Combine function and style with this ergonomic **ACHILLE** bed available in 2 styles!

✦ This 140x200cm convertible 190cm bed solution has 3 large storage drawers and 2 open niches, ideal for storing books or other items that are easily accessible.

✦ Complete the function with this industrial-style headboard with 7 niches

✦ Achille is available in an industrial style with its two-tone **Jackson Oak** and **Black Stipple** niche backs and handles, and now in a timeless, natural version with its **Jackson Oak** and **White** look.



| | |
|---------------|-------------|
| JACKSON OAK | JACKSON OAK |
| BLACK STIPPLE | WHITE |

The products are made in particule board with a thickness of 15 and 22 mm

Drawers are equipped with a roller runner system

ADULT BEDROOM / Achille



The ACHILLE function bed includes :

- 140x200 cm bed adaptable to 140x190 cm, available in 2 colours.
- 3 drawers
- Two large open niches
- 3 handles
- Headboard with 7 niches



L146 x H76 x P204cm; Weight : 56 kg -
Volume : 0,143m³; Number of packages : 2

3301L240 : Jackson Oak & White

3303L240 : Jackson Oak & Black Stipple



3303TETE : L182 x H21 x P99cm

Weight : 21kg - Volume : 0,061m³

Number of packages : 1

ADULT BEDROOM / Bianca



✦ Equipped with a head and foot-board in glossy white finish, this very contemporary model will allow you to give your room a modern look at a low price

✦ A bedside table with an 11 cm high **Glossy White** drawer is also available to complete your set-up

✦ A sober and natural style with **Matte White** and **Glossy White** finishes

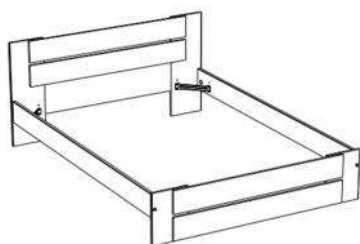

3071L140 : L146 x H75 x D195
Weight : 26 kg - Volume : 0,050m³

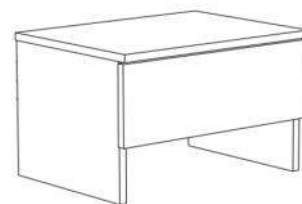

3071CHET : L44 x H29 x D33
Weight : 6 kg - Volume : 0,013m³

The products are made of particleboards with a thickness of 15 and 22 mm

The drawers are equipped with a ball-bearing runner system

WHITE

ADULT BEDROOM / Bridge



➤ Bridge is a complete, contemporary and space-saving bedroom that will allow you to integrate storage units, bedside tables, a wardrobe and shelves.

➤ The bed fits perfectly onto the headboard whose decorative black niche is illuminated by LEDs, giving your wall a modern touch while offering contrast.

➤ The headboard, thanks to its shallow depth, guarantees a small space requirement while freeing space for the bed.

➤ Bridge is available in two versions: **Brooklyn Oak** and **Black Stipple**, with its industrial loft style, and **Brooklyn Oak** and **Shiny White**, with its contemporary, natural Vintage look.



The products are made of chipboard, with a thickness of 15 mm

BROOKLYN OAK

BROOKLYN OAK

BLACK STIPPLE

SHINY WHITE



The Loft **BRIDGE** bed and headboard include :

- One 5-door headboard with an interior layout combining : 6 shelves, 1 retractable hanging rail, 5 niches, 2 retractable bedside shelves and LEDs with remote control
- 1 bed available in 2 sizes: 140 x 190 cm and 160 x 200 cm
- 1 bed drawer option which is adaptable to both 190 and 200 cm beds dimensions.



L: 2652 x H.: 2028 x P. : 398 mm ; Weight : 126; Volume : 0.243 ; Number of packages : 4

3130ENVI : Oak / Black Stipple
3230ENVI : Oak / Shiny White



3130L140 : L: 1674 x H.: 829 x P. : 1936 mm ; Weight : 33 ; Volume : 0.096 ; Number of packages: 1



3130TIRO : L:2000 x H.: 219 x P. : 507 mm ; Weight : 14 ; Volume : 0.029 ; Number of packages : 1

3130TIRO : Oak / Black Stipple
3230TIRO : Oak / Shiny White



3130L260 : L: 1674 x H.: 829 x P. : 2036 ; Weight : 35 ; Volume : 0.101 ; Number of packages : 1

ADULT BEDROOM / Dream



✦ **Dream** range is designed to give your bedroom with elegance and function.

✦ Adapt Dream piece of furnitures to your space with bed and its drawers included, a large 3-door wardrobe with drawers, a chest of 3 drawers and a bedside table with drawer. All the bedroom must-have are included in this range to create harmony and meet your storage needs.

✦ Inspired by nature, its luminous **White** colour is enhanced by fine lines in **Japanese Oak**, with delicate handles and contours creating a soft contrast. This Dream range is suitable for everyone, adults and teenagers alike, in contemporary or more traditional styles.



The products are made in particle board, with a thickness of 15 and 18 mm

WHITE

JAPANESE OAK

ADULT BEDROOM / Dream



The DREAM adult bedroom range includes :

- A 140x200cm bed with 3 drawers and open niches
- A chest of 3 drawers
- A 3-door wardrobe one of each is a mirror and 2 drawers. Wardrobe includes hanging rail and shelves
- A bedside table with drawer and niche

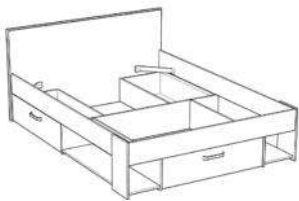

3302L140 : L: 146 x H.: 77 x P. : 205 cm; Weight : 58kg; Volume : 0.139m³; Number of packages : 2

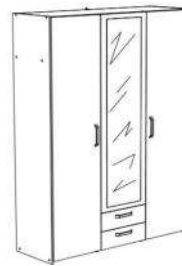

3302A3PM L: 150 x H.: 200 x P. : 52 cm ; Weight : 105kg; Volume : 0.186m³ ; Number of packages : 3



3302CH1T : L: 44 x H.: 34 x P. : 33 cm; Weight : 7kg; Volume : 0.016m³; Number of packages : 1



3302CO3T L: 80 x H.: 88 x P. : 44 cm; Weight : 30kg ; Volume : 0.064m³; Number of packages : 1

ADULT BEDROOM / Ekko



✦ EKKO reinvents itself by offering you a complete range to furnish your bedroom with a lot of storage solutions.

✦ A range that includes a bed in 2 sizes, 140x190 and 160x200cm, with optional bed drawers, and a bed headboard with spacious storage units all around the bed. If you prefer a simple bed, add a bedside table with drawer and a chest of 6 drawers to keep your essentials close at hand.

✦ Ekko adapts to your storage needs with its range of 3-door wardrobe or wardrobes with curtain and now with storage units that can stand alone or be combined in multiple configurations to create a dressing space including: a 2-door wardrobe and its entry cabinet with niche, mirror and coat hooks, its spacious storage unit with 2 sliding doors or its reversible corner unit with shelves and coat hooks.

✦ A trendy, clean and timeless style, thanks to the **Brooklyn Oak** color, which adds a touch of calm and nature. Ekko is a safe bet that will easily find its place in your bedroom.



*The products are made in particleboard, With a thickness of 15mm
Drawers are equipped with a ball-bearing runner system*

BROOKLYN OAK



The EKKO range, ideal for optimizing space includes :

- A bed available in 140x190cm or 160x200cm, with optional drawers
- A headboard with 2 doors and 3 interior shelves on each side, 3 doors above the bed and an open niche serving as a bedside cabinet with integrated cable management systems
- Bedside table with drawer
- Chest of 6 drawers
- A 3-door wardrobe + Wardrobe with curtain and 4 drawers
- A 2-door wardrobe with 3 inside shelves, An entry cabinet space with mirror, 3 shelves and 2 hooks
- A 2 sliding doors wardrobe with 2 retractable hanger holders and shelves
- Reversible corner storage with 3 niches and 3 hooks



3782L140 : L150 x H71 x P193cm
Weight : 25 kg - Volume : 0,050m3
Number of packages : 1



3782RANG : L153 x H203 x P57cm
Weight : 87 kg - Volume : 0,176m3
Number of packages : 3



3782RA2P : L140x H200 x P41cm
Weight : 78kg - Volume : 0,198m3
Number of packages : 3



3782L260 : L170 x H71 x P206cm
Weight : 30 kg - Volume : 0,076m3
Number of packages : 1

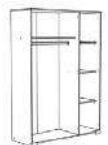

3782AR3P : L139 x H197 x P52cm
Weight : 94 kg - Volume : 0,179m3
Number of packages : 3



3782AR2P : L129 x H200 x P37cm
Weight : 69kg - Volume : 0,140m3
Number of packages : 3



3782ENVL : L230 x H138x P195cm
Weight : 29 kg - Volume : 0,061m3
Number of packages : 2



3782CO6T : L121 x H81 x P41cm
Weight : 43 kg - Volume : 0,087m3
Number of packages : 2



3782ANGL : L53 x H199 x P36cm
Weight : 26kg - Volume : 0,053m3
Number of packages : 1



3782TIRO : L189 x H22 x P51cm
Weight : 13 kg - Volume : 0,029m3
Number of packages : 1



3782CHEV : L40 x H41 x P33cm
Weight : 8 kg - Volume : 0,017m3
Number of packages : 1

ADULT BEDROOM / Escale



✦ Escale, an adult bedroom with a chic, natural style, includes hand-grip handles and discreet decorative mouldings.

✦ Discover the Escale bed in 140, 160 and 180cm and its removable bedside shelves let you personalise your headboard, thanks to its reversible Oak and White colour. Add drawers to optimise storage

✦ Escale offers a 3-door wardrobe with inside mirror and a reversible **Oak** or **White** vertical panel. Spacious, it will adapt to your needs thanks to its two hanging rails and 3 shelves. Complete your storage space with its harmonious 1-door 3-drawer chest.

✦ Inspired by the Japandi trend, this range in **Japanese Oak** colour is ideal for a relaxing, natural atmosphere.



The products are made of particleboard 15 and 22 mm thickness.

Chest drawers are equipped with a roller runner system

JAPANESE OAK

ADULT BEDROOM / Escale



The ESCALE nature inspired room includes :

- 140x200, 160x200cm and 180x200cm beds with headboard with reversible shelves in white and Japanese oak that serve as a bedside table.
- Optional set of two 51 cm-deep drawers
- A chest with a door and 3 drawers
- A 3-door wardrobe including 1/3 shelving part (3 shelves) and 2/3 hanging part and inside mirror.

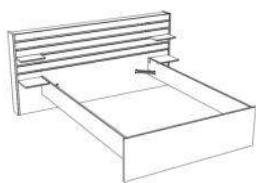

3580L240 : L203 x H98 x P217;
Weight : 56 kg - Volume : 0,119m3;
Number of packages : 2

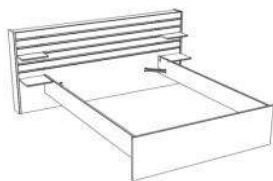

3580L260 : L223 x H98 x P217;
Weight : 59 kg - Volume : 0,133m3;
Nombre de colis : 3

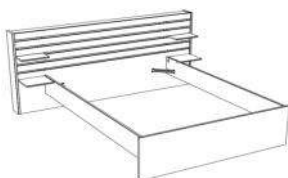

3580L280 : L235 x H98 x P217;
Weight : 62 kg - Volume : 0,134m3;
Nombre de colis : 3

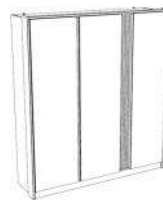

3580AR5C : L185 x H203 x P52
Weight : 132 kg - Volume : 0,276m3
Number of packages : 5



3580COPT : L110 x H77 x P50
Weight : 42 kg - Volume : 0,084m3
Number of packages : 2



3580T2RO : L199 x H22 x P51;
Weight : 13 kg - Volume : 0,031m3,
Number of packages : 1

ADULT BEDROOM / Horn



✦ With its clean lines and modern finish, HORN is a real design statement that will add a touch of elegance to your bedroom.

✦ Its functional headboard incorporates side storage and a long top that replaces your bedside table and creates a unified look in your bedroom.

✦ Horn offers you the opportunity to conceal storage by optimising space with a large drawer running the full length of the bed.

✦ **The Japanese Oak and Black Stipple** colours will turn your bed into a trendy, modern design feature.



*The product is made in particle board with a thickness of 15mm
The drawers are fitted with ball bearing slides*

JAPAN OAK

BLACK STIPPLE

ADULT BEDROOM / Horn



The HORN bed includes :

- A 140x190 bed that can be adapted to 140x200
- One long drawer 477mm deep with 2 handles
- Headboard with 4 side shelves
- 215mm long work surface

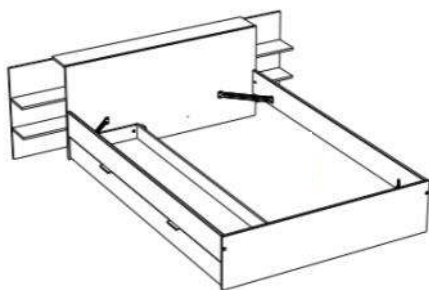

3299L240 : L208 x H67 x D224; Weight : 56 kg - Volume : 0.137m³; Number of packages : 2

ADULT BEDROOM / Lodge



✦ Lodge offers you functions and aesthetics with its adult bed and spacious headboard.

✦ The headboard has 4 storage niches and a large table top. The bed has a set of two drawers and a storage niche that can be positioned on the left or right side during assembly

✦ Available in two versions, Lodge adapts to your taste and style. Choose the elegant and sober two-tone **Brooklyn Oak** and **Black Stipple**, or the bright and warm **Brooklyn Oak** and **Home White** version.



The products are made of particle board, with a thickness of 15mm

The drawers are equipped with a roller runner system

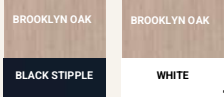

ADULT BEDROOM / Lodge



The functional and aesthetic LODGE bed includes :

- 4 side niches on the headboard
- 2 drawers adaptable to the left or right side
- A storage niche



Dimensions : L148 x H70 x P212

Weight : 47 kg - Volume : 0,094m³

Nombre of packages : 2

3783L140 : Oak | Black Stipple

3785L140 : Oak | White

ADULT BEDROOM / Most



✦ A functional bed with three L75 x D35 cm drawers with two of them reversible (can be assembled on the right or left hand side of the bed) and a headboard including 4 side storage compartments + a 15-cm-deep platform

✦ A natural style available in three different two-tone colours : **White | Light Acacia** and **Black Stipple | Jackson Oak** .

✦ The L240 bed version is adaptable to 140x190 cm or 140x200 cm mattress size



*The products are made of particleboards with a thickness of 15 and 22 mm
The drawers are equipped with a roller runner system*

| | |
|---------------|--------------|
| JACKSON OAK | LIGHT ACACIA |
| BLACK STIPPLE | WHITE |



The **MOST** bed includes :

- A sleeping dimension of 140x190 cm, 140x200 cm or 160x200 cm
- Three L75 x D35 cm drawers, two of them can be assembled on the right or left hand side of the bed
- An open storage compartment at the foot of the bed, next to the third drawer
- The headboard includes 4 lateral storage compartments with a space for cables + a 15 cm deep platform on the top of the headboard



Dimensions : L150 x H79 x P220
 Poids : 60 kg - Volume : 0,126m³
 Nombre de colis : 2

1530L240 : White | Light Acacia

1630L240 : Black Stipple | Jackson Oak

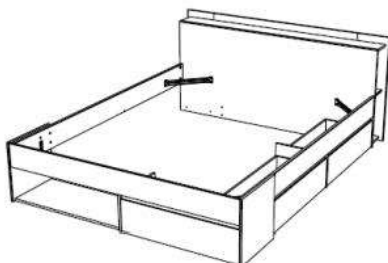

Dimensions : L170 x H79 x P220
 Poids : 64 kg - Volume : 0,129m³
 Nombre de colis : 3

1530L260 : White | Light Acacia

1630L260 : Black Stipple | Jackson Oak

ADULT BEDROOM / Nashville



✚ Available in three sizes 140x190 cm, 140x200 cm and now in 160x200cm, the Nashville bed has multiple storage spaces with two drawers and a shelf, which can be placed on the right or left side of the bed according to your wishes

✚ Match your Nashville industrial bed with the chest of drawers and bedside table in the same colour!

✚ The black metal effect of the handles matches the Black Stipple moulding for a trendy two-tone **Black Stipple | Jackson Oak** look. This model is also available in a more traditional **White | Silver Grey** two-tone look



*The products are made of particleboards with a thickness of 15 and 22 mm
The drawers are equipped with a ball-bearing runner system*

| | |
|-------------|---------------|
| WHITE | JACKSON OAK |
| SILVER GREY | BLACK STIPPLE |

ADULT BEDROOM / Nashville



The NASHVILLE bed includes :

- One bed available in 140x190 cm, 140x200 cm and now in 160x200cm
- Two L66 x D33 cm removable drawers with slim and trendy black metal effect handles that can be placed on the right or left side of the Bed
- A chest of 3 drawers and bedside table with one drawer
- A headboard with a Black Stipple molding for the Jackson Oak models or Silver Grey for the White models
- An additional storage space placed between the drawers

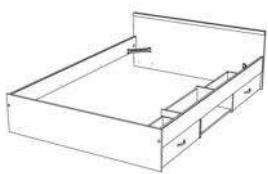

Sizes : L146 x H59 x P203, Weight : 35 kg -
Volume : 0.069m3, Number of packages : 2
2038L24T : White | Silver Grey



Sizes : L146 x H59 x P193, Weight : 35 kg -
Volume : 0.067m3, Number of packages : 2
2038L14T : White | Silver Grey
2078L14T : Jackson Oak | Black Stipple

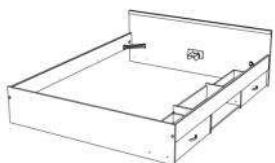

Sizes : L166 x H59 x P203, Weight : 39 kg -
Volume : 0.078m3, Number of packages : 3
2038L26T : White | Silver Grey
2078L26T : Jackson Oak | Black Stipple



2078CO3T : L80 x H88 x P44;
Weight : 30 kg - Volume : 0.064m3;
Number of packages : 1



2078CH1T : L40 x H34 x P30; Weight :
7 kg - Volume : 0.017m3; Number of
packages : 1

ADULT BEDROOM / Palante



✦ Transform your space with **Palante**, a room with a unique, modern look that creates a soft, warm harmony.

✦ This range offers a plush 140x200 bed that can be adapted to 190cm. Add some character with its suspended bedside cabinets with drawers, forming a beautiful headboard that adds an aesthetic balance to your wall.

✦ For added functionality, Palante offers a 4-door wardrobe and niche, a 1-door 3-drawer chest and a bed drawer option for a coherent, well-designed range.

✦ In a natural, contemporary style, Palante is available in **Japanese Oak** and **White** for an authentic look.



JAPAN OAK

WHITE

Products are made in particleboard with a thickness of 15 and 22 mm.

Drawers are equipped with a roller runner system

ADULT BEDROOM / Palante



The contemporary PALANTE room includes :

- A 140x200cm bed adaptable to 190cm
- 2 bedside table with drawers
- 1/3 linen cupboard, 2/3 closet with 4 doors and niche.
- A 3-drawer chest with door
- A bed drawer option



3509L240 : L147 x H92 x P207cm
Poids : 37kg - Volume : 0,093m3
Nombre de colis : 2



3509COPT : L113 x H78 x P40cm
Poids : 38kg - Volume : 0,089m3
Nombre de colis : 2

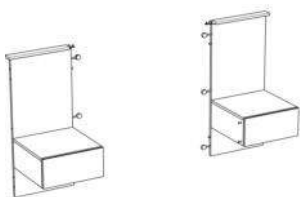

3509CHES : L41 x H92 x P43cm
Poids : 19kg - Volume : 0,046m3
Nombre de colis : 1



3509TIRO : L196 x H19 x P51cm
Poids : 12kg - Volume : 0,037m3
Nombre de colis : 1



3509AR4P : L122 x H184 x P50cm
Poids : 78kg - Volume : 0,180m3
Nombre de colis : 3

ADULT BEDROOM / Soluce



✦ Rediscover the essential Soluce bed, clean and elegant, now available in 2 sizes: 140x190 and 160x200!

✦ With a headboard including a trendy aluminum gray line, this elegant model will seduce you with its sleek style and excellent value for money

✦ Fresh and bright, the Matte White colour of Soluce beds is clean and contemporary. Don't be afraid to change the decoration of your room, your bed will adapt to all your customizations with its timeless colour. Soluce is a safe bet that will perfectly suit an adult or a teenager!



The products are made of particled board, with a thickness of 15 mm

WHITE



SOLUCE timeless beds include :

- A headboard with an aluminum line
- A clean and timeless matte white colour
- 2 dimensions: a bed 140x190cm and now 160x200 cm

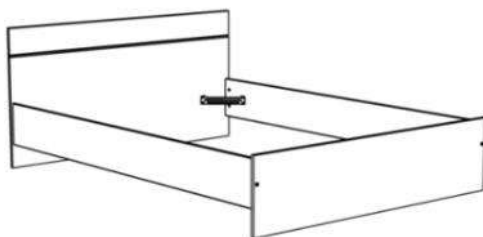

3023L140 : L145 x H75 x P193

Weight : 27 kg - Volume :
0,066m³; Number of packages : 1

3023L260 : L165 x H75 x P204

Weight : 30 kg - Volume :
0,068m³; Number of packages : 1

ADULT BEDROOM / Stamp



✦ Designed to fit a 140 or 160 cm wide bed base, the STAMP headboard has **multiple storage compartments** including 3 shelves on each side of the bed, as well as two bedside tables with one drawer each

✦ Stamp is available in Scandinavian-style with its minimalist design and two-tone look in **White Home | Artisan Oak**, ideal for creating a cosy, bright and welcoming place to sleep Discover the industrial version of Stamp in **Artisan Oak** with its contrasting **Back Stipple** bedside tables and frame.

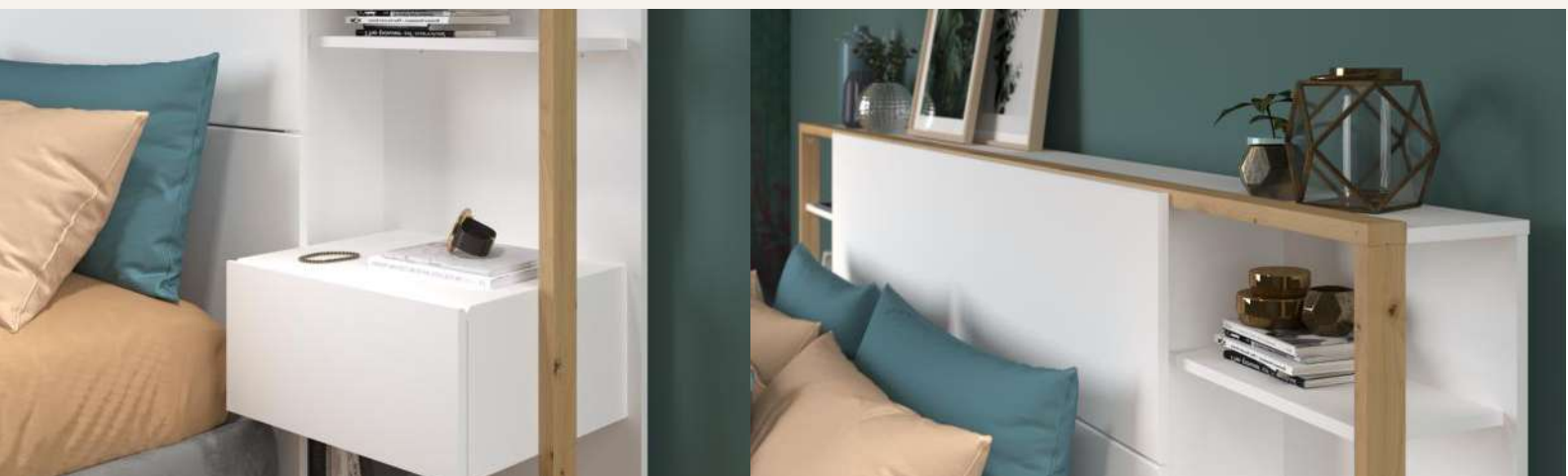

*The products are made of particleboards with a thickness of 15 mm
The drawers are equipped with a roller runner system + shock absorbers*

ARTISAN OAK

ARTISAN OAK

WHITE

BLACK STIPPLE



The functional and minimalist **STAMP** headboard includes :

- One slot for a 140 or 160 cm wide bed
- 6 storage shelves, with a depth of 18 and 33 cm
- Two 29 cm deep bedside tables with one drawer each equipped with roller runners and shock absorbers

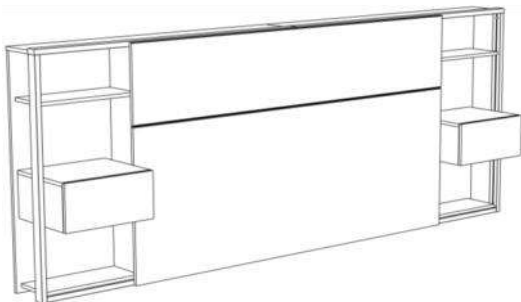

L255 x H103 x D36; Weight : 55 kg -
Volume : 0.122m³; Number of packages : 2

3199TETE : Artisan Oak & Blanc

3198TETE : Artisan Oak & Black Sipple

ADULT BEDROOM / Stamp



✦ Give your bedroom a new dimension with the **Stamp** bed bridge and bed frames, combining functionality and modernity to give your sleeping space a contemporary and trendy identity.

✦ The bed bridge, designed to optimize storage space, integrates 2 doors forming a wardrobe and linen closet, along with niches that provide a relief effect, accentuated by retractable bedside shelves. The bed bridge is perfectly suited for bed frames available in 140x190-200 and 160x200, to which you can add an optional drawer.

✦ The integrated bookshelf, equipped with subtle lighting, offers a practical space to store and display your books, decorative items, or favorite accessories, while bringing a cozy ambiance to your bedroom.

✦ With its **Artisan Oak design** and contrasting **Black Stipple touches**, Stamp brings character to your bedroom, combining the warmth of wood with clean lines for a chic and timeless look.



*The products are made in particule board, with a thickness of 15 mm
The drawers are equipped with a ball bearing systems*

ARTISAN OAK

BLACK STIPPLE



The **STAMP** character-filled bedroom includes:

A bed bridge featuring:

- 3 bookshelf shelves with a Black Stipple background, retro-lit by 2 LED kits.
 - 1 door concealing a retractable simple rail.
 - 1 door concealing a linen closet with 3 shelves.
 - 4 niches with a Black Stipple background.
- A bed frame available in 2 sizes: 140x200cm adaptable to 190cm, as well as a 160x200cm version.
 - An optional Black Stipple bed drawer.



3123ENVI : L265 x H203 x P40; Weight : 112 kg - Volume : 0.248m³; Number of packages : 1



3123L240 : L147 x H83 x P204; Weight : 36 kg - Volume : 0.117m³; Number of packages : 1



3123TIRO : L51 x H22 x P200; Weight : 12 kg - Volume : 0.035m³; Number of packages : 1



3123L260 : L167 x H83 x P204; Weight : 35 kg - Volume : 0.111m³; Number of packages : 1

ADULT BEDROOM / Toronto



✚ A complete and cosy adult bedroom with large storage capacity and two beds

✚ An industrial look of character with the combination of **Authentic Oak** - **Steam Black** decors accentuated by the metallic aspect of the furniture frames



The products are made of particleboards with a thickness of 15 and 18 mm

The drawers are equipped with a roller runner system

AUTHENTIC OAK

STEAM BLACK



The bedroom TORONTO includes :

- Two beds with dimensions of 140x190 cm and 160x200 cm, with a 95 cm high decorative headboard
- The possibility of adding drawers 51 cm deep, available as an option
- A set of two hanging bedside cabinets with drawers
- A chest of drawers with one door and 3 drawers
- A 4-door 2-drawer wardrobe with a storage area, two hanging areas and a large central mirror



3304L140 : L149 x H95 x D199
Weight : 45 kg - Volume : 0,097m3
Number of packages : 2

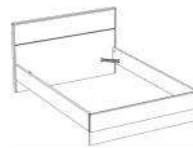

3304L260 : L169 x H95 x D209
Weight : 49 kg - Volume : 0,108m3
Number of packages : 2



3304TIRO : L189 x H17 x D51
Weight : 12 kg - Volume : 0,029m3



3304CHES : L43 x H95 x D43
Weight : 24 kg - Volume : 0,047m3



3304COPT : L113 x H80 x D42
Weight : 41 kg - Volume : 0,089m3
Number of packages : 2



3304A4PT : L188 x H196 x D52
Weight : 138 kg - Volume : 0,249m3
Number of packages : 4

ADULT BEDROOM / Travel



✦ Designed to fit out small spaces, this storage bed combines a double bed function with a real storage space underneath, thanks to its flip-up bed base

✦ Very trendy, this storage bed in **Artisan Oak | Black Stipple** tones is perfect to bring a touch of personality in an adult or teenager bedroom

✦ This bed also has a reinforced platform (22 mm thick) to allow you to create your own universe according to your desires



The products are made of particleboards with a thickness of 15 and 22 mm
The drawers are equipped with a roller runner system, the bed base with shock absorbers

ARTISAN OAK

BLACK STIPPLE



The storage bed **TRAVEL** includes :

- A bed base with dimensions of 140x200 cm adaptable to 140x190 cm
- 2 storage compartments of 31 cm in depth and a storage compartment closed by a drawer located on the side of the bed
- A 22 mm thick and 203 cm long platform just above + a second shelf of 20 cm in depth
- A total of four 30 cm high storage compartments with two of them are 45 cm deep, and a second drawer located under the bed
- Two 11 cm high platforms above these compartments which can be used for storing shoe boxes for example

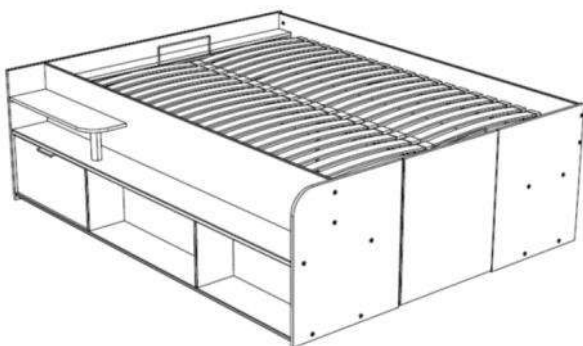

1540LICO : L166 x H67 x D206
Weight : 132 kg - Volume : 0.412m³
Number of packages : 5



LIVING ROOMS



✦ Transform your living space into an authentic, warm and welcoming environment with the EWEN living room, available in two colors

✦ Our 2, 3 and 4-door enfilades offer optimum storage capacity for your essentials. Whether you need to store crockery, books or games, each piece is designed to adapt to your daily needs. The table, with its 40cm extension that slides under the table, allows you to easily accommodate your guests, adjusting elegantly to all your occasions.

✦ Our TV units and walls are designed to optimize space and guarantee perfect visibility, and integrate storage solutions for your multimedia devices.

✦ Combining the chic of Jackson Oak with the modernity of White or Black Stipple, Ewen blends perfectly with all interior styles, from contemporary to classic. The Oak color brings warmth and character, while the sleek white or black finishes add a touch of sophistication. Let yourself be seduced by a collection that combines functionality, elegance and timelessness for a living room that reflects your personality.



JACKSON OAK

JACKSON OAK

BLACK STIPPLE

WHITE

The products are made in particleboard with a thickness of 15 and 22 mm

Les tiroirs sont équipés d'un système de coulisse à billes



The EWEN two-tone living room includes :

- A table with a 40cm extension leaf. The extension can be stored directly under the table.
- Three sidboards configurations: 4, 3 and 2 doors with interior shelves
- TV unit with 1 door, 1 sliding door and 1 shelf
- A TV wall to be placed above the TV cabinet, comprising 2 hinged doors, 1 sliding door and 8 shelves



0302TARE : L156-194 x H75 x P90cm; Weight : 48kg - Volume : 0,099m³; Number of packages : 2

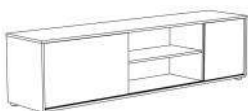

L180 x H46.5 x P40cm; Weight : 30kg - Volume : 0,066m³; Number of packages : 1

0302BATV : Jackson Oak & White

0312BATV : Jackson Oak & Black Stipple



L216 x H198 x P28cm; Weight : 52kg - Volume : 0,110m³; Number of packages : 2

0302PATV : Jackson Oak & White

0312PATV : Jackson Oak & Black Stipple



L184 x H83 x P40cm; Weight : 52kg - Volume : 0,046m³; Number of packages : 2

0302EN4P : Jackson Oak & White

0312EN4P : Jackson Oak & Black Stipple

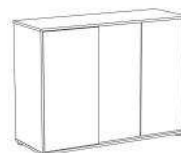

L110 x H83 x P40cm; Weight : 32kg - Volume : 0,068m³; Number of packages : 1

0302EN3P : Jackson Oak & White

0312EN3P : Jackson Oak & Black Stipple



L80 x H83 x P40cm; Weight : 23kg - Volume : 0,046m³; Number of packages : 1

0302EN2P : Jackson Oak & White

0312EN2P : Jackson Oak & Black Stipple

LIVING ROOM / Fumay



✦ Give more character to your home with this contemporary living room in a modern combination of **Rough Oak** and **Dark Concrete** tones

✦ A collection of plush furniture with reassuring shapes and thicknesses for a relaxing and harmonious living room



The products are made of particleboards with a thickness of 15, 22 and 28 mm

The drawers are equipped with a roller system for the console and a ball bearing system for the TV bench

ROUGH OAK DARK CONCRETE



The **FUMAY** modern-contemporary living room includes :

- a TV bench with a 22-mm-thick top, a door, a drawer and a storage compartment
- A coffee table with 28 mm thick crosspieces and two trays
- A TV wall unit with open and closed storage spaces for a TV up to 55 inches

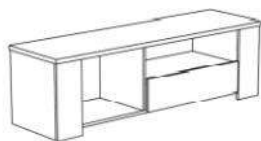

9432BATV : L138 x H41 x D40
Weight : 29 kg - Volume : 0,058m³



9432TABA : L105 x H37 x D73
Weight : 30 kg - Volume : 0,067m³



9432PATV : L166 x H138 x D41
Weight : 53 kg - Volume : 0,102m³
Number of packages : 2

TV UNIT / Leviathan



Possibilité de positionner le meuble au sol grâce à ses patins à clouer

✦ Transform your living room with the Leviathan TV stand, an elegant and functional solution that combines minimalist design with practicality.

✦ Leviathan stands out for its modularity: it can be suspended for a sleek look or placed on the floor using nail-down glides, adapting to all your space configurations.

✦ To further personalise your space, several pieces of Leviathan furniture can be combined to create a unique and harmonious perspective.

✦ With its **Kronberg Oak** colour, adding a natural, contemporary touch to your interior, its minimalist design and meticulous finishes, Leviathan combines elegance, sturdiness and practicality to enhance your living room and meet your needs.



9310BATV : L138 x H29 x D40cm

Weight : 21kg - Volume : 0,045m³

Number of packages : 1

LIVING ROOM / Lundge



✦ Discover the innovative LUNDGE high table that adapts to your needs and your guests!

✦ With its 28cm folding extension leaf, this high table offers unrivalled flexibility. Simply rotate the extension leaf to transform your table from 2 to 4 people in the blink of an eye. There's no need for bulky tables with this versatile table, which can be used for snacking and as a central island, or as a comfortable table for 4.

✦ With its sliding doors at the front, this high table provides easy access to your kitchen utensils, crockery and other essential items for entertaining. Make the most of your guests without worrying about the organisation of your space.

✦ With its refined design, this high table harmoniously combines Scana Oak for its warm top with sleek white doors. This modern, well-balanced look will fit in perfectly with your living space.



The products are made in particleboard with a thickness of 15 mm

SCANA OAK

WHITE



The **LUNDGE** removable high table with storage includes:

- High table with 280 mm folding extension leaf
- Suitable for 2 to 4 diners
- 5 niches
- Front sliding doors
- Weight capacity on extension: 15KG



8015TAHT : L110 x H93 x D82; Weight :
k45g - Volume : 0.093m3; Number of
Packages : 2



✦ Transform your home with Maelle, a versatile and elegant range designed to suit any environment. With its modern finishes and harmonious design, Maelle combines functionality with aesthetic appeal.

✦ Comprising 6 models, this range includes a sideboard with optional extension to create a modular solution that's ideal for maximising storage while adapting to your space, as well as an open bookcase that's perfect for displaying your books or decorative objects while adding a light, modern touch to your room.

✦ These elements can be combined to create a harmonious environment, from the living room to the dining room. Their design allows you to play with contrasts and textures to personalise your decor as you wish.

✦ Maelle offers a predominantly white version with oak detailing for a bright, timeless look, while the predominantly oak version with white detailing offers natural warmth and a contemporary feel.



The products are made in particle board with a thickness of 15 and 22 mm

WHITE

JAPAN OAK



The MAELLE modular range includes :

- A bookcase with 11 open niches, 1 door and 1 drawer
- A TV cabinet with 2 niches, 2 doors with interior shelves and a drawer
- A riser to add to the TV unit with 7 open niches, 2 doors with interior shelves.



L : 138 cm ; H. : 73 cm ; D. : 35 cm ;
Weight : 36 kg ; Volume : 0.072 m3 ;
Number of packages : 1

0802BAPT : White and Japan Oak

0803BAPT : Japan Oak and White



L : 137cm ; H. : 125 cm ; D : 28 cm ;
Weight : 33 kg ; Volume : 0.071 m3 ;
Number of packages : 1

0802REHA : White and Japan Oak

0803REHA : Japan Oak and White



L : 118 cm ; H: 198 cm ; D : 40cm ;
Weight : 73 kg ; Volume : 0.145m3 ;
Number of packages : 3

0802BIBL : White and Japan Oak

0803BIBL : Japan Oak and White

LIVING ROOM / Morphos



✦ Discover our Morphos range, where pure design meets functionality. This collection embodies the perfect balance between modernity and natural warmth.

✦ The enfilade and sideboard provide a storage solution with their doors and niches, allowing optimum organisation while adding a designer touch to your interior. Their design, with integrated handholds, makes them masterpieces for enhancing your living space.

✦ The coffee table, with its lift-up top, frees up clever storage space while making the most of your space. As for the TV unit, it combines functionality and modernity thanks to its open niche and drawer.

✦ Finished in warm **White** and **Japanese Oak**, Morphos furniture creates a welcoming and sophisticated ambience. Versatile and easy to integrate, it allows you to personalise your interior while enjoying durable quality and innovative design.



JAPAN OAK

WHITE

The products are made in particle board with a thickness of 15 and 22 mm

The drawers are fitted with a ball bearing runner system

LIVING ROOM / Morphos



The MORPHOS nature and minimalist living room includes :

- A 3-door sideboard with an open niche
- A TV cabinet with 2 doors, a drawer and an open niche
- A sideboard with 2 doors and 2 niches.
- A coffee table with raised top



0400EN3P : L150 x H75 x D40cm; Weight : 35kg - Volume : 0,081m3; Number of packages : 1



0400BATV : L150 x H47 x D40cm; Weight : 24kg - Volume : 0,057m3; Number of packages : 1



0400BAHU : L84 x H135 x D40cm; Weight : 33kg - Volume : 0,073m3; Number of packages : 1



0400TABA : L110 x H45 x D60cm; Weight : 25kg - Volume : 0,069m3; Number of packages : 2

LIVING ROOM / Paradoxe



✦ Paradox: the subtle combination of modern elegance and everyday practicality

✦ A selection of furniture to suit all your furnishing needs: a 3-door sideboard offering spacious storage, a 2-door bookcase combining display and discretion, and a compact, functional 2-door sideboard. Each piece combines practicality and clever storage solutions to simplify your daily life.

✦ Its lounge area is functional, with a practical, convertible coffee table and 4-door TV unit ideal for organising your multimedia items.

✦ The design of the Paradoxe range is distinguished by its subtle 3D effect, with overlapping elements creating a sense of depth to add dynamism. The Authentic Oak tone contrasts with the Shadow Grey, adding a warm, contemporary touch. This bold, structured style fits perfectly into a modern interior.



*The products are made in particle board with a thickness of 15 and 22 mm
Drawers are fitted with a metal roller runner system*

AUTHENTIC OAK

SHADOW GREY



The contemporary PARADOXE range includes :

- A 3-door sideboard with interior shelves
- A bookcase with 3 shelves behind a glass door and a solid door
- A sideboard with a glass door and a full door
- A coffee table that can be raised from 47 to 67cm high with a 110x60cm mobile space. Two niches open to the side.
- A TV unit with 4 doors



0806E3PT : L184 x H89 x D33-42cm, Weight : 56kg; Volume : 0.122m³; Number of packages : 2



0806BATV : L184 x H53 x D42cm, Weight : 40kg; Volume : 0.082m³; Number of packages : 2



0806BA2P : L95 x H138 x D33-42cm, Weight : 38kg; Volume : 0.077m³; Number of packages : 2



0806TABA : L110 x H47-67 x D65cm, Weight : 37kg; Volume : 0.082m³; Number of packages : 1



0806BIBL : L95 x H138 x D33-42cm, Weight : 48kg; Volume : 0.091m³; Number of packages : 2

LIVING ROOM / Portland 2



✦ Our must have natural and contemporary living room has been reinvented in a more authentic and friendly version, discover PORTLAND 2

✦ A range with reassuring lines, both rounded and straight, that will enable you to entertain comfortably thanks to its extendable table and 4-door sideboard. Portland 2 also offers more compact storage to suit your needs, with a 140cm fixed table and a 3-door sideboard.

✦ Its coffee table and TV unit are designed in a warm, traditional style to match your living room with your dining room.

✦ Portland 2 is a timeless value with a charming **Kronberg Oak** colour. This natural living room will easily find its place in your living space and will suit all your decorating styles.



The products are made of particleboard, 15, 18 and 22 mm thickness.

Drawers are fitted with a roller runner system + shock absorbers

KRONBERG OAK



The PORTLAND 2 authentic living room includes :

- A 156cm long table with a 35cm extension
- A 140cm fixed table
- Two sideboards of 3 and 4 doors with inside shelves
- TV unit with 2 doors and 2 horizontal niches
- A coffee table with a lower shelf



0347TARE : L156/191 x H78 x P90;
weight : 54 kg - Volume : 0,117m3;
Number of packages : 2



0347EN3P : L153 x H82 x P43;
weight : 49 kg - Volume : 0,106m3;
Number of packages : 2



0347TA14 : L138 x H77 x P80;
weight : 35 kg - Volume : 0,088m3
Number of packages : 1

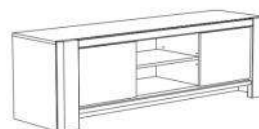

0347BATV : L151 x H45 x P43;
weight : 29 kg - Volume : 0,066m3
Number of packages : 1



0347EN4P : L197 x H82 x P43;
weight : 61 kg - Volume : 0,125m3;
Number of packages : 2



0347TABA : L110 x H 42 x P63;
weight : 24 kg - Volume : 0,061m3
Number of packages : 1

LIVING ROOM / Sophia



✦ The Sophia TV stand combines design and practicality to enhance your interior. Its clean lines and charming charm make it the ideal centerpiece for a refined your living room with refinement.

✦ With two doors and two spacious drawers, the Sophia TV stand offers a practical storage solution for your multimedia accessories, remote controls and cables. But the ingenuity doesn't stop there! Thanks to its extension option, you'll benefit from additional surfaces to further optimize storage, while maintaining a sleek look.

✦ Need more storage options ? Combine this TV unit with a wide selection of bookcases and doors from the range of the same name, for customized organization without compromising the visual harmony of your space.

✦ The 63cm-high TV stand features a timeless, authentic design. Its charming style is enhanced by three different finishes: **Jackson Oak** and **Celadon Green**, **Jackson Oak** and **White** or total look **White**. Add character to your space with a sturdy, functional piece of furniture.



*The products are made in particleboard with a thickness of 15mm.
Drawers are equipped with roller runner systems*

| | | |
|---------------|-------------|-------|
| JACKSON OAK | JACKSON OAK | WHITE |
| CELADON GREEN | WHITE | |



The SOPHIA range of modular TV stands includes:

- 3 versions; Jackson Oak and Celadon Green, Jackson Oak and White, White.
- 2 doors
- 2 interior shelves
- 2 drawers
- Oak handles on the Oak and Green versions, Black and White tab handles on the other versions
- 3-shelf extension option
- A dressing-room extension option to be added to the white module



L.: 158 x H.: 63 x P. : 40 cm; Weight : 44kg; Volume : 0.091m³; Number of packages : 2

8430BUTV : Jackson Oak and Celadon Green

8431BUTV : Jackson Oak et White



8430REHA : L.: 79 x H.: 135 x P. : 28 cm; Weight : 22kg; Volume : 0.041m³; Number of packages : 1



8432DRES : L.: 158 x H.: 60 x P. : 40 cm; Weight : 36kg; Volume : 0.079m³; Number of packages : 1

TV UNIT / Thebes



✦ Discover our timeless TV unit **THEBES**, ideal for small spaces and small budgets!

✦ Equipped with two practical niches, this TV unit provides an ideal space to organize your multimedia devices, remotes, and decorations.

✦ The combination of Brooklyn Oak and White creates a subtle contrast that adds warmth to your interior. This TV unit, with its simplicity, brings a fresh touch to your living room while staying in line with current trends.



9270BATV : L90 x H38 x P33cm;
Weight : 10kg - Volume : 0,019m3
Number of packages : 1

LIVING ROOM / Tomy III



✦ This timeless, essential piece of TV furniture has been reinvented in new versions: Discover **Tomy III**

✦ This practical TV unit has plenty of storage space for several multimedia devices and an open space at the back for running cables.

✦ Tomy III also has a sliding door, ideal for small spaces.

✦ This functional TV unit is available in two distinct styles: **Jackson Oak** and **White** for a natural look, or Jackson Oak and Black Stipple for a modern contemporary look.

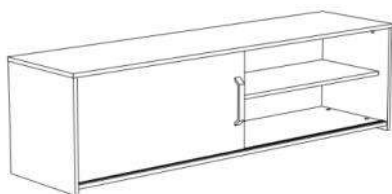

L : 155 ; H : 43 ; P : 40 cm; Weight : 24kg;

Volume : 0.048m³; Number of packages : 1

9302BATV : Jackson Oak + White

9312BATV : Jackson Oak + Black Stipple

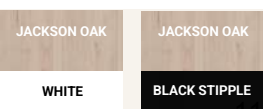



✦ A table—sideboard set with an **industrial** style, large feet and a trendy two-tone decoration in **Dark Grey | Artisan Oak**

✦ A quality finish, with ABS edges, metal handles and decorative apparent bolts

✦ A functional collection with marked lines revealing numerous storage spaces through reassuring shapes



0397TABL : L224 x H78 x D90/93
Weight : 57 kg - Volume : 0,127m³
Number of packages : 2



0397E3PT : L220 x H87 x D52
Weight : 92 kg - Volume : 0,182m³
Number of packages : 3

The products are made of particleboards with a thickness of 15 and 22 mm
The drawers are equipped with a roller runner system and metal handles

LIVING ROOM / Wendy



✦ A living room with a natural, contemporary style, with a Dakota Oak tone, rounded shapes and hand-grip handles for a warm, welcoming interior.

✦ Discover our timeless coffee table and new TV unit, redesigned to meet your needs in terms of design, functionality and style. Our pieces are designed to blend in perfectly with all decoration style.

✦ A collection of living room essentials at an attractive price, including a new rounded table with extension, a TV bench with open and closed storage, a 4-door sideboard and now a coffee table!



DAKOTA OAK

The products are made on particleboard, with a thickness of 15 and 22 mm

Drawers are fitted with a roller runner system



The contemporary WENDY living room includes :

- A rounded table with an extension of 35cm
- A 185 cm long sideboard with 4 doors and a central drawer. The interior is fitted with 2 shelves
- A TV unit with 2 closed storage compartments and 2 open storage niches
- A functional coffee table with drawer and integrated chest



0191TARO : L120/156 x H120 x P77cm; Weight : 35.8 kg - Volume : 0,117m3, Number of packages : 2

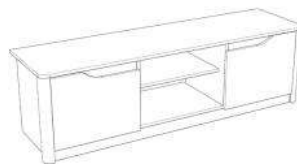

0191BAT2 : L150 x H42 x P40cm; Weight : 26 kg - Volume : 0,059m3; Number of packages : 1

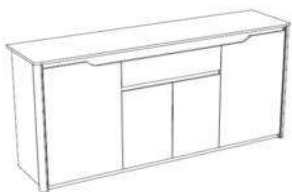

0191ENFI : L185 x H86 x P46cm; Weight : 63 kg - Volume : 0,128m3 Number of packages : 2

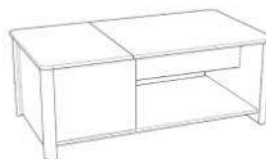

0191TABA : L110 x H42 x P60cm; Weight : 28 kg - Volume : 0,059m3; Number of packages : 1



STORAGE & FURNITURE

STORAGE / Celest



✦ Need to organise and dress up your entry hall ? Discover our Celest range

✦ A range designed for respond to all your storage needs with its sideboard its 3-door and 2-drawer sideboard, its 2-door or sliding doors sideboard and its two versions of shoe cabinets including: a 4-flap model

✦ A chest of 6 drawers and a chest of 3 drawers complete this storage range.

✦ The Celest range fits into any room in the house, thanks to its shallow depths and timeless colours. The warm **Brooklyn Oak** is contrasted by its **Black Stipple** pieces and the fine lines of the handles.



*The products are made in particleboard, with a thickness of 15 mm
Drawers are fitted with a metal ball bearing runner system*

BROOKLYN OAK

BLACK STIPPLE



CELEST storage range includes:

- A 3-doors and 2 drawers sideboard with 2 shelves inside
- A 2-doors cupboard with 2 shelves inside
- A 2 sliding doors cupboard
- A 1.5m high shoe cabinet with 4 flaps and removable compartments
- A 1m high shoe cabinet with 2 flaps with removable compartments and 1 drawer
- A chest of 3 drawers
- A chest of 6 drawers



0982BAPT : L118 x H83 x D40cm.
Weight : 38 kg - Volume : 0,077m3
Number of packages : 1

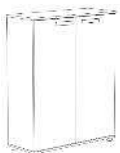

0982BA2P : L80 x H103 x D33cm;
Weight : 25 kg - Volume : 0,058m3
Number of packages : 1



0982BAPC : L80 x H103 x D33cm;
Weight : 26 kg - Volume : 0,058m3
Number of packages : 1



0982CO3T : L78 x H80 x D40cm;
Weight : 28 kg - Volume : 0,057m3; Number of packages : 1



0982MCH4 : L78 x H154 x D24cm;
Weight : 29 kg - Volume : 0,078m3
Number of packages : 1



0982MCH2 : L80 x H103 x D30cm;
Weight : 26 kg - Volume : 0,056m3
Number of packages : 1

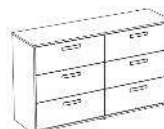

0982CO6T : L138 x H80 x D40cm;
Weight : 50 kg - Volume : 0,101m3; Number of packages : 2

STORAGE / Daily 2



✚ The Daily range has been reinvented with storage units that are ever more functional and adapted to your needs. Daily 2 is perfected by improving the ease of its assembly and thus your comfort!

✚ Available in the sober tones **White** or **Jackson Oak** and now in **Jackson Oak and Black Stipple**, this range combines great storage capacity and aesthetics by harmonizing with all your decoration styles

✚ 185 cm high cabinets available in 3 configurations: 2-door and 3-door with or without mirror, 4-door with or without mirror. Daily 2 is now offering a 2-metre-high, 150-cm wardrobe with 3 mirrored doors.



*The products are made of particleboards, with a thickness of 15 mm
The drawers are equipped with a ball-bearing runner system*

JACKSON OAK

WHITE

JACKSON OAK

BLACK STIPPLE



The new **DAILY 2** storage range includes:

- A wardrobe available with two, three or four doors (for a total length of 81, 120 or 160 cm) with or without mirror and equipped with Grey aluminum finish plastic handles with the White and Oak version or Black with the industrial version.
- New 2m high and 150cm wide 3-door wardrobes with mirrors
- A closet bar and several storage niches according to the model
- New generation drawers with easy assembly



L81 x H185 x D51.cm, Weight : 64 kg -
Volume : 0,136m3. Number of Packages : 2
6510A2PT : White
6521A2PT : Jackson Oak



L81 x H185 x D51 cm, Weight : 68kg -
Volume : 0,140m3, Number of Packages : 2
6510A2PM : White
6521A2PM : Jackson Oak

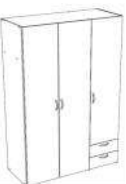

L120 x H185 x D51 cm, Weight : 78kg -
Volume : 0,158m3, Number of Packages : 2
6510A3PT : White
6521A3PT : Jackson Oak



L120 x H185 x D51cm, Weight : 81 kg -
Volume : 0,162m3, Number of Packages : 2
6510A3PM : White
6521A3PM : Jackson Oak
6531A3PM : Jackson Oak + Black Stipple



L160 x H185 x D51cm, Weight : 107
kg - Volume : 0,211m3, Number of
Packages : 3
6510A4PT : White
6521A4PT : Jackson Oak



L160 x H185 x D51 cm, Weight : 114 kg
- Volume : 0,217m3, Number of
Packages : 3
6510A4PM : White
6521A4PM : Jackson Oak
6531A4PM : Jackson Oak + Black Stipple



L150 x H200 x D51cm, Weight : 105 kg -
Volume : 0,186m3, Number of
Packages : 3
6540A3PM : White
6551A3PM : Jackson Oak
6541A3PM : Jackson Oak + Black Stipple

STORAGE / Galaxy



✚ A complete range including a 6-door and 3-drawer wardrobe, a 4-drawer chest, a bedside table with 1 drawer and a desk with 3 drawers.

✚ A whitelook enhanced by modern feet and handles for any bedroom.



WHITE

*The products are made of particleboards with a thickness of 12,5 and 15 mm
The drawers are equipped with a ball-bearing runner system*

STORAGE / Galaxy



The **GALAXY** storage range includes :

- A 120-cm-long desk with 3 drawers
- A bedside table with 1 drawer
- 1 chest 4 drawers of 25 cm high and 40 cm deep
- A 203-cm-high wardrobe with 6 doors and 3 drawers



5350CH1T : L40 x H41 x P33
WEIGHT: 8 kg - Volume : 0,017m³



5349BURE : L120 x H75 x P50
WEIGHT: 25 kg - Volume : 0,056m³

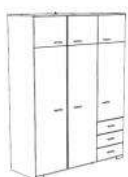

5366A6PT : L146 x H203 x P55
WEIGHT: 106 kg - Volume : 0,199m³
NUMBER OF PACKAGES: 4



5354CO4T : L77 x H106 x P40
WEIGHT: 32 kg - Volume : 0,068m³

BOOKCASE / Gaming



Lay it out the way you like!

✦ A bookcase with a completely customisable layout with its two trapezoidal doors that can be positioned on the left or on the right

✦ The shaped doors reveal part of the storages and highlight the central display niche composed of a glass shelf lit by a discreet LED kit



BLACK STIPPLE

The products are made of particleboards with a thickness of 15 and 22 mm

BOOKCASE / Gaming



✦ Very trendy, this beautiful bookcase in **Black Stipple** colour will easily find its place in your interior, becoming a real asset for your decoration

✦ Combine several bookcases to create an original shape, according to your wishes



6940BI2P : L67 x H180 x D28
Weight : 32 kg - Volume : 0,073m3
Number of packages : 2

HALL CABINET / Ghost



Brighten up your home with the Ghost cabinet!

✚ This very functional cabinet has all the necessary storage space to become indispensable: a wardrobe area, three storage compartments, a drawer as well as a lower storage unit with a sliding door

✚ Inspired by the *Japandi* trend and endowed with sober and pure lines, this elegant cabinet in **Japanese Oak | White** and **Artisan Oak | Black Stipple** tones also integrates a claustra creating a soft and bright atmosphere



L110 x H183 x D40

Weight : 48 kg - Volume : 0,096m3

Number of packages : 2

7628VEST : Japanese Oak / White

7629VEST : Artisan Oak / Black Stipple

The products are made of particleboards with a thickness of 15 mm

The drawers are equipped with a roller runner system



FILING CABINET / Ludik



✚ A Storage unit for files and documents designed to offer maximum storage capacity with minimum space requirements

✚ This storage unit are perfectly adapted to the SOPHIA bookcase range available in **Dakota Oak**

✚ The drawers are equipped with metal rods to hang your files. The top drawer is also equipped with a key lock



9846CLAS : L44 x H106 x D40cm;
Weight : 22kg , Volume : 0,050m3;
Number of Packages : 1

*The products are made of particleboards with a thickness of 15 mm
The drawers are equipped with a roller runner system*

BOOKCASE / Mayence



✦ MAYENCE consists of several bookcases that can be combined indefinitely.

✦ The range includes a practical desk that can also be combined with the bookcases. So adapt your workspace to your storage needs !

✦ Various options can be available such as doors or decorative glass doors in "workshop" style or simple doors.

✦ Mayence adapts to your wishes. You can combine the sizes you like with the options you want. They are available in three colours, **Home White**, **Black Oak** and **Japanese Oak**, depending on your preferences and now in **Roasted Elm**

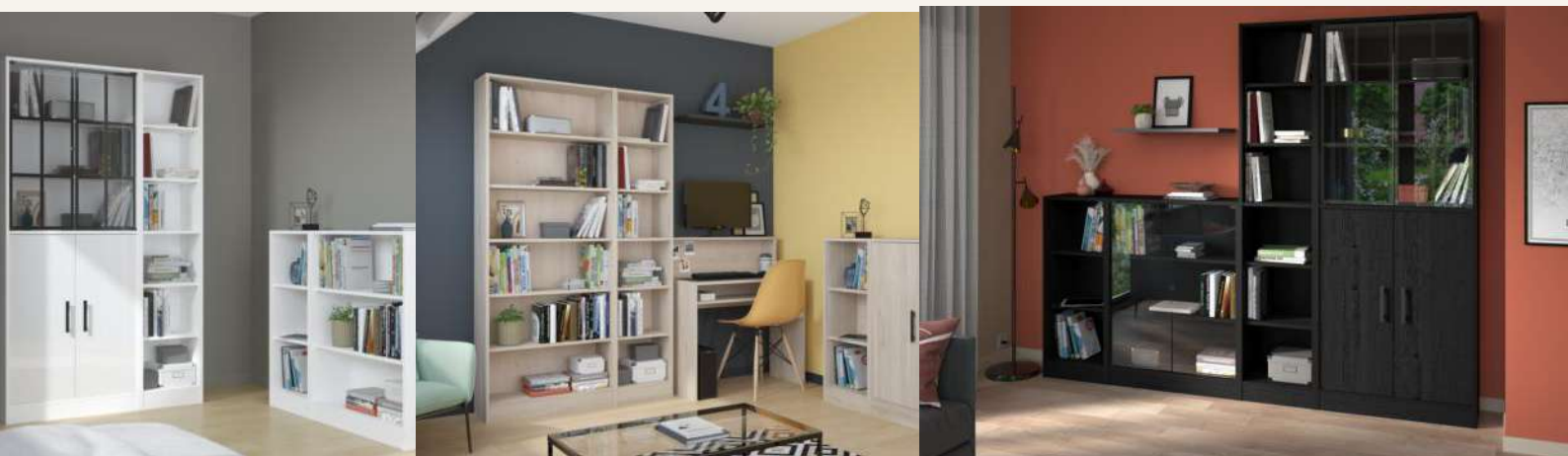

The products are made of particleboards with a thickness of 18 mm.

WHITE

JAPANESE
OAK

CABEZONE
OAK

ROASTED
ELM



The **MAYENCE** bookcase range includes:

- 4 storage sizes : a tall bookcase, a narrow tall bookcase and 2 low bookcases available in 3 colours.
- 1 Japanese oak desk with a niche and a hutch that can be combined with the bookcases.
- An option of industrial style glass doors or standard glass doors.
- A door option available in Home White, Japanese Oak and Black Oak.



L : 79 cm - H. : 198 cm - P. : 28 cm; Weight : 35kg ;
Volume : 0.073m³ ; Number of packages : 1

8243BIBL : WHITE

8241BIBL : CABEZONE

8242BIBL : JAPANESE OAK

8433BIBL : ROASTED ELM



L : 79 cm - H. : 104 cm - P. : 28 cm; Weight : 20kg ;
Volume : 0.042m³ ; Number of packages : 1

8283BIBU : WHITE

8281BIBU : CABEZONE

8282BIBU : JAPANESE OAK

8433BIBU : ROASTED ELM



L : 41 cm - H. : 198 cm - P. : 28 cm; Weight : 25kg ;
Volume : 0.050m³ ; Number of packages : 1

8223COLO : WHITE

8221COLO : CABEZONE

8222COLO : JAPANESE OAK

8433COLO : ROASTED ELM



8322BURE : L. : 91 cm - H. : 105 cm - P. : 50cm;
Weight : 21kg ; Volume : 0.050m³ ; Number of
packages : 1 JAPANESE OAK



L. : 35 cm - H. : 91 cm - P. : 1 cm; Weight : 8kg ;
Volume : 0.021m³ ; Number of packages : 1

8315PORV : VERRE ATELIER

8316PORV : SANS SERIGRAPHIE



L : 41 cm - H. : 104 cm - P. : 28 cm; Weight : 14kg ;
Volume : 0.031m³ ; Number of packages : 1

8263BIBU : WHITE

8261BIBU : CABEZONE

8262BIBU : JAPANESE OAK

8433B2BU : ROASTED ELM



L. : 71 cm - H. : 91 cm - P. : 1,5 cm; Weight : 8kg ;
Volume : 0.021m³ ; Number of packages : 1

8291PORP : BLACK OAK

8292PORP : JAPANESE OAK

8317PORP : SHINY WHITE

8433PORP : ROASTED ELM

FILING CABINET / Milo



✦ A range of three and four drawer file and document cabinets with generous storage capacities

✦ The drawers are equipped with metal rods to hang your files. The top drawer is also equipped with a key lock

✦ These filing cabinets with Japanese Oak fronts have White or Black Stipple surrounds and handles for a soft, natural atmosphere



Dimensions : L44 x H106 x D40
Weight : 24 kg - Volume : 0,05m³
7424CLAS : White | Japanese Oak version
7426CLAS : Black Stipple | Japanese Oak version



Dimensions : L44 x H138 x D40
Weight : 31 kg - Volume : 0,064m³
7425CLAS : White | Japanese Oak version
7427CLAS : Black Stipple | Japanese Oak version

The products are made of particleboards with a thickness of 15 mm

The drawers are equipped with a roller runner system

JAPANESE OAK

WHITE

JAPANESE OAK

BLACK STIPPLE

STORAGE / Minkee



✚ Did you like our Minkee wardrobe ? Let yourself be seduced by its Black version !

✚ Rediscover an elegant 3-door wardrobe with a mirror and a 5 shelf storage space, a hanging rail and two drawers with a roller runner system

✚ The charming leather handles on the MINKEE wardrobe are very comfortable to use and add a touch of sophistication. Available in White et now in Black Stipple, Minkee never ceases to surprise you while keeping its function and aesthetics clean and elegant.



The products are made in particleboards, with a thickness of 15 mm

The drawers are equipped with a roller runner system

BLACK STIPPLE

WHITE

STORAGE / Minkee



MINKEE wardrobes include :

- 3-door wardrobe with mirror and 2 drawers
- 1/3 storage space with 5 shelves
- 2/3 storage space with hanging rail and top shelf
- 4 leather handles

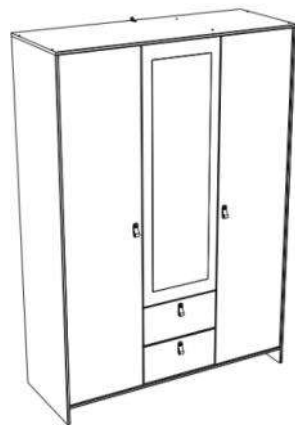

L137 x H196 x P52cm

Weight : 103 kg - Volume : 0,199m³

Number of packages : 3

6482A3PT : White

6492A3PT : Black

STORAGE / Neo



✦ Rediscover timeless, functional NEO storage units

✦ Available in **White** or **Brooklyn Oak** to perfectly suit your interior design

✦ A range for a low price including bedside table with two drawers, two chests of drawers with 3 or 6 drawers. All without handles for a neutral look that suits all interiors



The products are made of particleboards, with a thickness of 12, 15 and 18 mm for the top of the furniture
The drawers are equipped with a ball-bearing runner system

BROOKLYN OAK

WHITE



The NEO storage range includes :

- Two 82-cm-high chests of drawers with three and six drawers
- A 48-cm-high bedside table with two drawers



Dimensions : L40 x H48 x P33cm; Weight : 11 kg - Volume : 0,023m3; Number of Packages : 1

5900CH2T : White version

5993CH2T : Brooklyn Oak version



Dimensions : L77 x H82 x P40cm; Weight : 30 kg - Volume : 0,056m3; Number of Packages : 1

5903CO3T : White version

5996CO3T : Brooklyn Oak version



Dimensions : L77 x H82 x P40cm; Weight : 30 kg - Volume : 0,056m3; Number of Packages : 2

5901CO6T : White version

5994CO6T : Brooklyn Oak version



✚ A 38 cm deep wardrobe with two doors and one drawer perfect for small spaces thanks to its small footprint

✚ Orlando is suitable for all ages and all your storage needs. You can easily use it in a bedroom, an office or an entry hall.

✚ This wardrobe with its pure lines adapts to your taste and style with a **Home White** colour for a sober and bright look.



6580A2PT : L78 x H170 x D38cm,
Weight : 47 kg - Volume : 0,095m3
Number of packages : 2



✦ Discover OSAKA, the ideal solution for organising your shoes with style and efficiency

✦ With 2 doors and 1 drawer, our range of shoe cabinets offers generous storage space for all your pairs. The 3 shelves with mouldings are specially designed to swivel to 2 positions (0° & 30°), allowing you to adapt the layout to your needs.

✦ With a usable depth of 162 mm, even large shoes up to size 44 will fit without taking up space.

✦ With its Japanese Oak colour and black details, our range of shoe cabinets combines functionality and aesthetics. Its sleek, modern design blends perfectly with different interior styles, adding a touch of sophistication to your hallway or any other room.

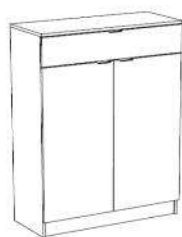

8399MCHA : L118 x H48 x D15cm;
Weight : 33kg; Volume : 0,085m3;
Number of Packages : 1

*The product is made in particle board with a thickness of 15mm
The drawers are fitted with ball bearing slides.*

JAPAN OAK

BLACK STIPPLE

BOOKCASE / Sophia



✚ The SOPHIA range reinvents the library by offering a modular and customizable concept that adapts to all your needs, creating unique and tailor-made storage spaces

✚ First, choose the frame of your library from three elegant finishes: **White**, **Jackson Oak**, or **Roasted Elm**. Then, personalize it by selecting doors according to your preferences: solid doors for a sober look, framed doors for a charming atmosphere, glass doors for a design touch, or opt for a clean style by leaving the shelves open.

✚ Whether in the living room, bedroom, or even the office, the Sophia range adapts to all spaces. The different sizes of units and columns allow you to compose furniture that optimizes every corner of your interior while combining functionality and style. Moreover, it is easy to mix these elements with other ranges like Ewen, Sophia TV furniture, etc.

✚ With its clean lines and refined finishes, the Sophia range exudes modernity while remaining warm. Whether you opt for light tones or darker woods, this library integrates perfectly into all types of decoration.



WHITE

JACKSON OAK

ROASTED ELM

The products are made in particule board, with a thickness of 18 mm

BOOKCASE / Sophia



The SOPHIA bookcases range includes:

- A 198cm high bookcase
- A half bookcase 104cm high
- A 198cm high column
- A half column 104cm high
- A framed door in Celadon Green
- Solid doors in **Oak** or **White**, with White and Black handles
- A glass door screen-printed in Celadon



L.: 78 x H.: 198 x P. : 28 cm;
Weight : 35kg; Volume :
0.074m³; Number of
packages : 1

8430BIBL : Jackson Oak
8433BIBL : Roasted Elm
8243BIBL : White



L.: 41 x H.: 198 x P. : 28 cm;
Weight : 25kg; Volume :
0.050m³; Number of
packages : 1

8430COLO : Jackson Oak
8433COLO : Roasted Elm
8223COLO : White



L.: 78 x H.: 104 x P. : 28 cm;
Weight : 19kg; Volume :
0.042m³; Number of
packages : 1

8430BIBU : Jackson Oak
8433BIBU : Roasted Elm
8283BIBU : White



L.: 41 x H.: 104 x P. : 28 cm;
Weight : 14kg; Volume :
0.031m³; Number of
packages : 1

8430B2BU : Jackson Oak
8433B2BU : Roasted Elm
8263BIBU : White



8430PORV : L.: 75 x H.:
92 x P. : 4cm; Weight :
10kg; Volume : 0.022m³;
Number of packages : 1

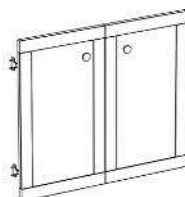

8430PORC : L.: 75 x H.:
66 x P. : 2cm; Weight :
7kg; Volume : 0.015m³;
Number of packages : 1



L.: 75 x H.: 91 x P. : 2cm;
Weight : 8kg; Volume :
0.021m³; Number of
packages : 1

8431PORP : White
8431P2RP : Jackson Oak



DRESSING

DRESSING KIT / Bali



✦ Adopt the BALI Complete Dressing Kit available in 2 dimensions for uncompromising organisation, clever functionality and style that reflects your distinctive taste.

✦ Make the most of your space with the Bali shelves parts, featuring 4 wide shelves for your clothes, shoes and accessories. The 60 cm white drawer provides a secure space for your personal items, while adding an aesthetic touch with its two-tone design.

✦ Simplify your morning routine with the double wardrobe. Two wardrobe rails, strategically placed at the top and bottom, provide an efficient storage solution for your clothes.

✦ Immerse yourself in timeless elegance with the soft colour palette of **Acacia** and **White**. Its elegant, modern design blends harmoniously into any space. Its grey curtain adds a contemporary touch, creating a perfect balance between functionality and aesthetics.

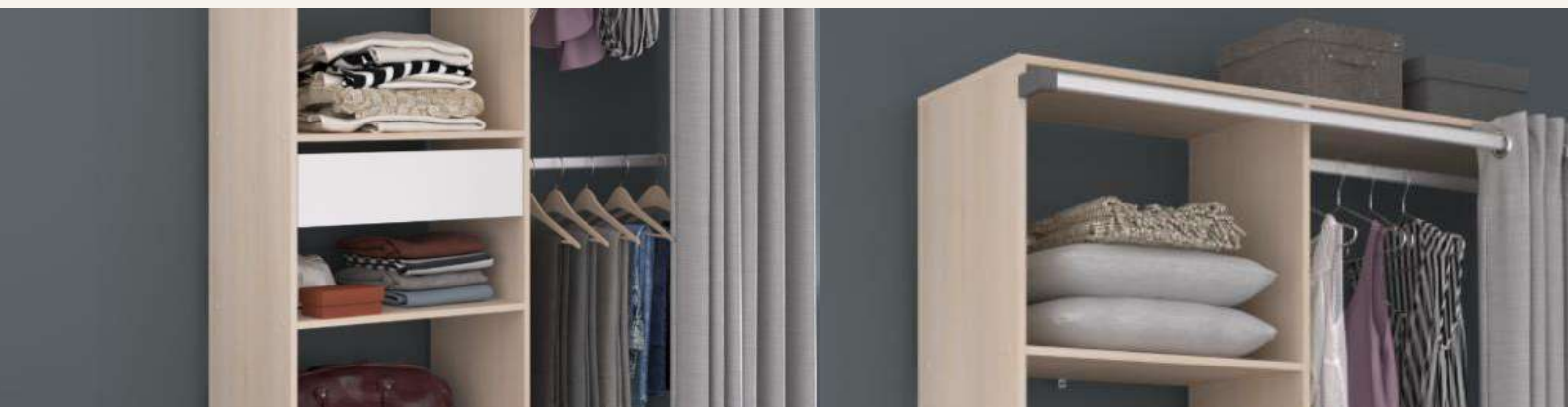

The products are made in particleboard with a thickness of 15 mm

The drawer is equipped with ball bearing runner systems

ACACIA

WHITE

DRESSING KIT / Bali



The BALI dressing in soft shades includes :

- Available in 180 and 200cm height
- Shelving parts with 4 wide shelves and a 60 cm white drawer on ball bearing runners, 2 hanging rails for top and bottom parts
- 210cm grey polyester curtain with 12 eyelets



BALI AMEN.PLAC.ACACIA

301350 : L143 x H182 x P48cm,
Weight : 41kg ; Volume : 0.092m3;
Number of packages : 1

5064DRES : L143 x H202 x P48cm,
Weight : 43kg ; Volume : 0.098m3;
Number of packages : 1

Dressing Kit / Bali Indus



✦ Adopt the BALI INDUS Complete Dressing Kit for uncompromising organisation, clever furnishing and a style that reflects the boldness of industrial design. Free up your space while adding a touch of modernity where functionality meets urban style.

✦ Maximise your space with the shelves parts with 4 wide shelves, ideal for storing your clothes, shoes and accessories. The 60 cm black drawer provides a secure space for your personal belongings, while adding a touch of modernity.

✦ Simplify your daily routine with the 2 hanging rails, judiciously positioned at the top and bottom provide a practical storage solution for your clothes. There's no need to compromise - everything's within easy reach.

✦ Bring out the industrial aesthetic with the Bali Indus dressing, combining the character of **Acacia** with the depth of **Black**. Its sleek, modern design. Its black curtain and drawer add a touch of sophistication, creating a contemporary, urban atmosphere.



The products are made in particleboard with a thickness of 15 mm

The drawer is equipped with ball bearing runner systems

ACACIA

BLACK STIPPLE

Dressing Kit / Bali Indus



The BALI INDUS industrial dressing includes :

- Shelving parts with 4 wide shelves and a 60 cm white drawer on ball bearing runners, 2 hanging rails for top and bottom parts
- 210cm grey polyester curtain with 12 eyelets



BALI INDUS ACACI/NOI

301190 : L143 x H182 x P48cm,

Weight : 41kg ; Volume : 0.092m³;

Number of packages : 1

Dressing Kit / Bari



✦ Opt for the Complete BARI Dressing Kit for flawless organization, ingenious features, and a minimalist, timeless style that expresses your unique aesthetic.

✦ Maximize the use of your space with the Bari linen column, equipped with 4 spacious shelves to organize your clothes, shoes, and accessories. The 60 cm white drawer ensures secure space for your personal items while providing a bright look.

✦ Facilitate your morning routine with the double wardrobe. With two cleverly positioned bars at the top and bottom, it offers an efficient storage solution for your clothes.

✦ Explore pure elegance with the all-**White** look of the dressing. Its monochrome palette, with its sleek and modern design, will harmonize perfectly in any space. The gray curtain adds a contemporary touch, creating a subtle balance between functionality and aesthetics for a refined and timeless all-white style.

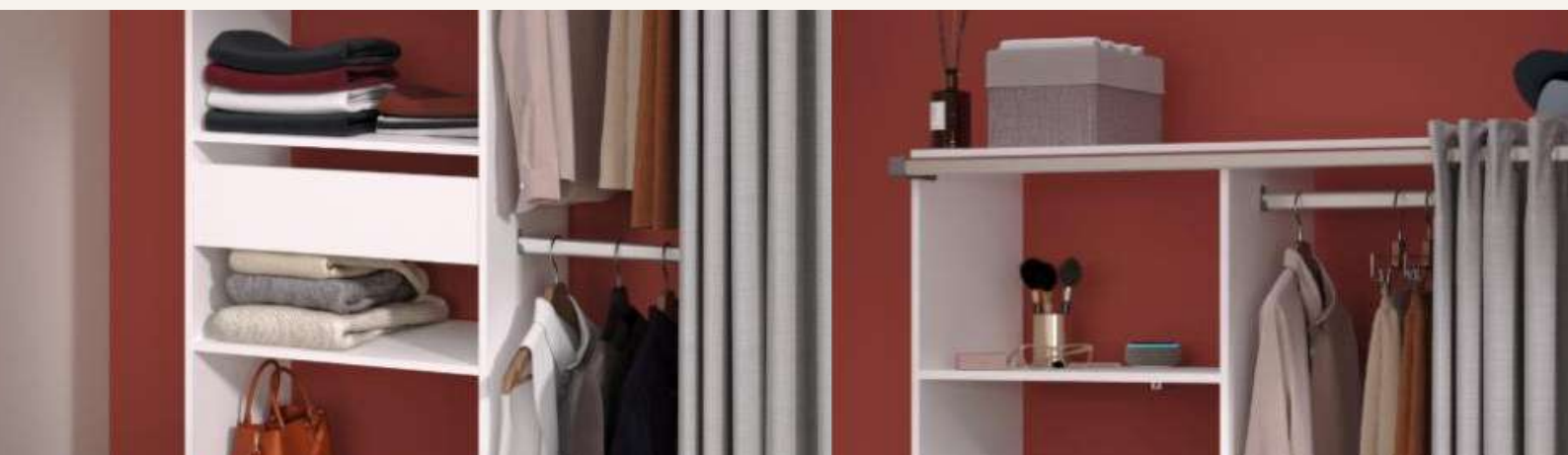

The products are made of particleboard, with a thickness of 15 mm.

The drawer is equipped with ball-bearing slides.

WHITE

Dressing Kit / Bari



The BARI White dressing kit includes :

- Shelves parts with 4 large shelves and a 60 cm white drawer on ball-bearing slides, 2 wardrobe bars for upper and lower parts
- 210 cm gray polyester curtain on 12 eyelets



BARI AMENAG.PLAC. 400

301340 : L143 x H182 x P48cm,

Weight : 41kg ; Volume : 0.092m3;

Number of packages : 1

Dressing Kit / Chicago



✦ Explore a new dimension of storage with our modular dressing, offering exceptional flexibility to create 13 unique CHICAGO storage solutions.

✦ Choose from five distinct modules to create the perfect configuration. Opt for the shelves parts with a width of 60 cm or 38 cm depending on your space needs, add a drawer for organized storage, determine the ideal height between 180 cm and 200 cm, and adjust the width from 138 cm to 220 cm. These options allow you to design a wardrobe suited to your space and preferences.

✦ With the option to add a grey curtain, you have complete control over the aesthetics of your space. Organize your wardrobe out of sight by adding a curtain or leave it open for a minimalist look.

✦ The combination of **Brooklyn Oak** and contrasting **Shadow Grey** edges creates a contemporary atmosphere. Whether your style is classic or avant-garde, this collection adapts to all trends, allowing you to personalize your space with a timeless look.



The products are made of particleboard, with a thickness of 18 mm.

The drawers are equipped with ball-bearing slides.

BROOKLYN OAK

SHADOW GREY

Dressing Kit / Chicago



The modular CHICAGO dressing includes :

- Shelves parts width 60 cm or 38 cm: with drawer and top shelf
- Optional adjustable width extension
- Optional finishing side panel
- Optional curtain column H203 cm



CHICAGO C CH.BROOK.

300230 : L139 x H180 x P40cm,
Weight : 32kg ; Volume : 0.078m3;
Number of packages : 1



CHICAGO G CH.BROOK.

300270 : L199 x H203 x P48cm,
Weight : 31kg ; Volume : 0.083m3;
Number of packages : 1



CHICAGO D CH.BROOK.

300240 : L160x H180 x P40cm,
Weight : 37kg ; Volume : 0.090m3;
Number of packages : 1



CHICAGO E CH.BROOK.

300250 : L1.8 x H180 x P40cm,
Weight : 10kg ; Volume : 0.041m3;
Number of packages : 1



CHICAGO F CH.BROOK.

300260 : L140 x H203 x P40cm,
Weight : 36kg ; Volume : 0.087m3;
Number of packages : 1

Dressing Kit / Combi



✚ Do you dream of a custom storage space that perfectly fits your needs and lifestyle? Discover our COMBI customizable dressing kit, an ingenious and polyvalent solution that offers endless personalization to create an organized and aesthetic space.

✚ Unleash your creativity with our 7 combinable elements, offering no less than 26 different configurations to meet your specific storage needs. Opt for custom features by choosing whether or not to add drawers and curtains according to your preferences for optimal organization of your clothes and accessories.

✚ Because every space is unique, Combi offers a wide selection of dimensions to perfectly fit your room. Choose from widths ranging from 138 to 220 cm and heights from 180 to 200 cm to create a dressing that perfectly harmonizes with your environment.

✚ The elements with clean lines and **White** decor bring a touch of modernity while harmoniously integrating into any style of decoration.



The products are made of particleboard, with a thickness of 15 mm.

The drawers are equipped with ball-bearing slides.

WHITE

Dressing Kit / Combi



The modular COMBI white dressing includes :

- Shelves parts width 60 cm or 38 cm: with or without drawer and top shelf
- Optional adjustable width extension kit
- Optional finishing side panel
- Optional curtain column H203 cm



COMBI A BLANC AME.PLA
301510 : L138 x H180 x P40cm,
 Weight : 21kg ; Volume : 0.054m3;
 Number of packages : 1

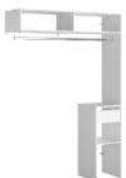

COMBI F BLANC AME.PLA
301580 : L139 x H203 x P40cm,
 Weight : 31kg ; Volume : 0.074m3;
 Number of packages : 1



COMBI B BLANC AME.PLA
301520 : L160 x H180 x P40cm,
 Weight : 25kg ; Volume : 0.066m3;
 Number of packages : 1



COMBI G BLANC AME.PLA
301590 : L200 x H203 x P48cm,
 Weight : 26kg ; Volume : 0.072m3;
 Number of packages : 1



COMBI C BLANC AME.PLA
301530 : L138 x H180 x P40cm,
 Weight : 14kg ; Volume : 0.031m3;
 Number of packages : 1



COMBI D BLANC AME.PLA
301540 : L160 x H180 x P40cm,
 Weight : 31kg ; Volume : 0.078m3;
 Number of packages : 1



COMBI E BLANC AME.PLA
301550 : L1.6 x H180 x P40cm,
 Weight : 8kg ; Volume : 0.038m3;
 Number of packages : 1

Dressing Kit / Combi Indus



✦ Dive into the world of custom storage with our industrial-style modular dressing. A perfect blend of functionality and raw aesthetics, COMBI Indus adds a touch of character to your space.

✦ Express your individuality with our 8 combinable elements, offering a palette of 30 configurations. Customize your dressing by choosing between drawers and curtains for optimal discretion. Discover also the exclusive possibility of adding a elements with an industrial-style glass door, bringing a unique dimension to your space.

✦ Your space, your rules. The range offers a variety of dimensions to fit your room, with widths from 138 to 220 cm and heights from 180 to 200 cm.

✦ Explore the bold aesthetics of our dressing in **Jackson Oak** and **Black**. The oak elements bring natural warmth, while the industrial black adds a contemporary touch. The option of an industrial-style glass door enhances the whole, creating an authentic focal point in your storage space.



The products are made of particleboard, with a thickness of 15 mm.

The drawers are equipped with ball-bearing slides.

JACKSON OAK

BLACK STIPPLE

Dressing Kit / Combi Indus



The modular and industrial COMBI INDUS dressing includes : :

- A B C D: base elements
- Shelves parts width 60 cm or 38 cm: with or without drawer and top shelf
- E: Optional finishing side panel
- F: Optional adjustable height extension kit H203 cm
- G: Optional curtain column H203 cm
- H: Optional column with mirror door + black curtain H180.4 cm



COMBI INDUS A AME.PLA

305510 : L138 x H180 x P40cm, Weight : 21kg ; Volume : 0.054m3; Number of Packages: 1



COMBI INDUS F AME.PLA

305580 : L139 x H203 x P40cm, Weight : 31kg ; Volume : 0.074m3; Number of Packages : 1



COMBI INDUS B AME.PLA

305520 : L160 x H180 x P40cm, Weight : 25kg ; Volume : 0.066m3; Number of Packages : 1



COMBI INDUS G AME.PLA

305590 : L200 x H203 x P48cm, Weight : 26kg ; Volume : 0.072m3; Number of Packages : 1



COMBI INDUS H AME.PLA

305570 : L202 x H180 x P54cm, Weight : 43kg ; Volume : 0.100m3; Number of Packages: 1



COMBI INDUS C AME.PLA

305530 : L138 x H180 x P40cm, Weight : 14kg ; Volume : 0.031m3; Number of Packages : 1



COMBI INDUS D AME.PLA

305540 : L160 x H180 x P40cm, Weight : 31kg ; Volume : 0.078m3; Number of Packages: 1



COMBI INDUS E AME.PLA

305550 : L1.6 x H180 x P40cm, Weight : 8kg ; Volume : 0.038m3; Number of Packages: 1

Dressing Kit / Corido



✦ Reorganize your wardrobe with two complete and compact dressers. Discover the elegance and practicality embodied in the CORIDO dresser and its White look !

✦ The two 38 cm shelves parts, each with 4 shelves and a drawer, provide polyvalent storage for your clothes, accessories, and personal items. Additionally, the 2 adjustable hanging rails allow you to customize the arrangement of your dresser according to your preferences, thus maximizing space usage.

✦ The adjustable winter shelf allows you to customize the space to your seasonal needs, offering a flexible solution for all items.

✦ Choose the timeless elegance of **White** with a modern aesthetic. The clean lines and finishes add a sophisticated touch to your space, creating an environment where style perfectly matches functionality.



The products are made of particleboard, with a thickness of 15 mm.

The drawers are equipped with ball-bearing slides.

WHITE

Dressing Kit / Corido



The modern CORIDO dressing includes :

- 2 shelves parts of 38 cm width, with 4 shelves and a drawer on ball-bearing slides.
- External panels height of 202 cm.
- Adjustable winter shelf.
- 2 hanging rails
- 210 cm gray polyester curtain on a metal support (adjustable).

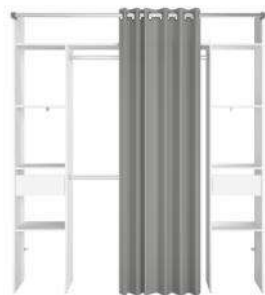

CORIDO AMENA.PLAC.BLC

300750 : L176 x H203 x P48cm, Weight : 53kg ; Volume : 0.138m³; Number of packages: 2

Dressing / Cosy



✦ Redefine your space with the COSY complete dressing, which combines functionality and style for effortless organisation.

✦ Cosy is an all-in-one dressing with a height of 2m. It has a wide linen column with drawers and a tall wardrobe, bringing together all the essential functions for optimised storage. The 5 shelves and 60 cm black drawer provide organised space, while the wardrobe area with 2 shelves and 1 black lacquered wardrobe rail guarantees a complete solution.

✦ The black curtain adds a touch of privacy and elegance to your space. It cleverly hides your personal belongings while creating a neat aesthetic. The closed dressing room with curtain is an ideal solution for keeping your room looking neat and homogenous.

✦ The **Dakota Oak** and **Black** decor creates a warm, modern atmosphere. The black accents - the back of the column, the wardrobe rail, the curtain and the handle - add a touch of sophistication. The combination of wood and black creates a contemporary aesthetic, making Cosy an essential element of a stylish yet functional interior.



The products are made in particleboard with a thickness of 15 mm

Drawers are fitted with ball bearing slides

DAKOTA OAK

BLACK



COSY dressing includes :

- Hanging space with 2 shelves and 1 black lacquered hanging rail.
- Black curtain on black lacquered tube.
- Matt black lacquered metal handle.
- Black drawer interior.
- Tall unit with 5 shelves and a 60 cm black drawer on ball bearing runners.
- Back of unit in black.



COSY

302180 : L161 x H200 x D50cm,
Weight : 65.2kg ; Volume : 0.142m3;
Number of packages : 2



Design your dressing room as you want it !

✚ **EXTENSO** is an innovative wardrobe line, offering multiple possibilities for layout, functionality and aesthetic combinations

✚ Create the storage solution you want, whether linear or angled, open or closed, thanks to our 23 references, including :

- 2 structure decors
- 7 front models



The products are made of particleboards with a thickness of 15 and 18 mm

STORAGE / Extenso



STRUCTURES L 50 & L 100

- ✚ The structures are available in **White** or **Brooklyn Oak** with a textile coloured base and incorporate a shelf and a hanging bar
- ✚ They also feature a self-centring assembly system for quick assembly and optimum security
- ✚ A corner kit can also be used to create a corner module when combined with a L100 structure



Dimensions : L100 x H232 x D59
 Weight : 61 kg - Volume : 0,122m3
 Number of packages : 2
4430CA10 : White version
4432CA10 : Brooklyn Oak version



Dimensions : L50 x H232 x D59
 Weight : 47 kg - Volume : 0,093m3
 Number of packages : 2
4430CA50 : White version
4432CA50 : Brooklyn Oak version



Dimensions : L98 x H232 x D32
 Weight : 47kg - Volume : 0,096m3
 Number of packages : 1
4440ANGL : White version
4441ANGL : Brooklyn Oak version



0042RA10 : L96 x H4 x D50
 Weight : 11,5 kg - Volume : 0,020m3



0043TI50 : L46 x H27 x D50
 Weight : 7 kg - Volume : 0,015m3



0043TI10 : L96 x H27 x D50
 Weight : 10 kg - Volume : 0,020m3



0044TI52 : L46 x H54 x D50
 Weight : 14 kg - Volume : 0,028m3



0044TI12 : L96 x H54 x D50
 Weight : 19 kg - Volume : 0,035m3



0045TIPP : L96 x H16 x D50
 Weight : 9 kg - Volume : 0,020m3



0049BA10 : L96 x H3 x D1,5
 Weight : 0,4 kg - Volume : 0,001m3



0042RA50 : L46 x H4 x D50
 Weight : 6 kg - Volume : 0,010m3



4430FILE : L10 x H232 x D1,8
 Weight : 3 kg - Volume : 0,006m3

STORAGE / Extenso



Brooklyn Oak

4432PB50

L49,9 x H229 x D1,5

Weight : 13 kg

Volume : 0,065m³



White

4430PB50

L49,9 x H229 x D1,5

Weight : 13 kg

Volume : 0,065m³



Blanc + Mirror

4442PBCA

L49,9 x H229 x P1,9

Poids : 16 kg

Volume : 0,073m³



Glossy White

4436PB50

L49,9 x H229 x D1,5

Weight : 13 kg

Volume : 0,065m³



Mirror

4434PB50

L49,9 x H229 x D1,9

Weight : 13 kg

Volume : 0,065m³



Black Stipple

4445PB50

L49,9 x H229 x D1,5

Weight : 14 kg

Volume : 0,068m³



Black + Mirror

4433PB50

L49,9 x H229 x D3,5

Weight : 18 kg

Volume : 0,065m³

Dressing Kit / Exto



✚ EXTO, the adjustable-width dressing that enhances your storage space. With its essential features and innovative design, EXTO offers a flexible solution, ideal for simplifying your daily life!

✚ EXTO offers an adjustable width from 103 to 161.3 cm without the need to cut the panel. This feature allows you to adapt the dressing to your space without constraints, offering a custom solution for efficient storage.

✚ With its 2 hanging rails, EXTO offers double hanging capacity, ideal for organizing your clothes optimally. The 60 cm shelves parts, equipped with 4 shelves and 1 drawer, as well as the 200 cm high riser with 2 storage niches, add essential functions for optimal organization.

✚ Its contemporary **White** design integrates perfectly into any interior, bringing a touch of freshness and brightness to your space. Whether in a bedroom, a master suite, or a dressing room, EXTO combines timeless style with sophisticated functionality.



The products are made of particleboard, with a thickness of 15 mm.

The drawers are equipped with ball-bearing system.

WHITE

Dressing Kit / Exto



The adaptable EXTO Dressing includes:

- An extendable storage solution from 103 to 161.3 cm in width without cutting the panel
- 60 cm wide linen column with 4 shelves and 1 drawer
- Riser with 200 cm height, 2 storage niches
- 2 wardrobe bars



EXTO AMENA.PLA BLANC

300020 : L161-103 x H203 x P40cm,
Weight : 46kg ; Volume : 0.113m³;
Number of packages : 2

Kit Dressing / Gary



✦ Transform your storage space with the Complete GARY Dressing Kit! Enjoy perfect organization with a compact curtain setup. Discover a new dimension of practicality and style for your daily life.

✦ Gary includes an intelligent shelves part with adjustable shelves allowing you to customize the space according to your needs, while a spacious drawer offers an organized solution for your accessories.

✦ Whether you have long or short clothes, Gary offers a clever 2 hanging rails, providing ample space for all your clothes. Keep your wardrobe well-organized and within reach.

✦ Dive into the warm aesthetics of **Dakota Oak** and **White** with this dressing kit. Whether in a bedroom, a master suite, or even a dressing room, Gary integrates harmoniously, adding timeless elegance to your interior.

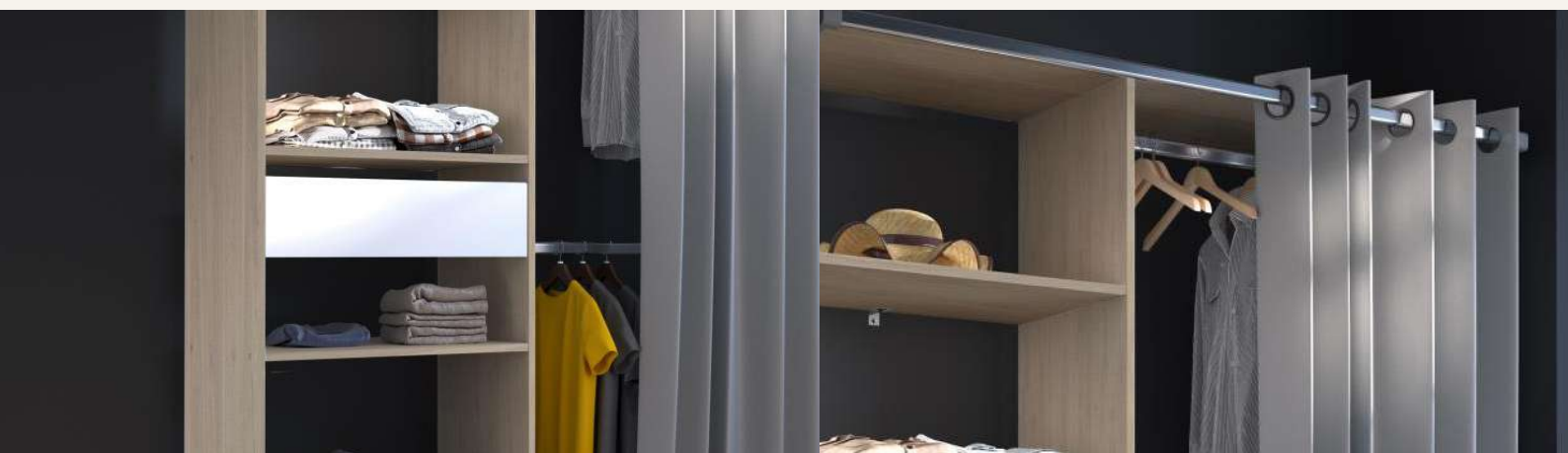

The products are made of particleboard, with a thickness of 15 mm.

The drawers are equipped with ball-bearing slides.

DAKOTA OAK

WHITE



The complete Oak & White GARY wardrobe includes:

- Column with 4 large shelves and a 60 cm white drawer on ball-bearing slides, 2 wardrobe bars for upper and lower parts
- 210 cm gray polyester curtain on 12 eyelets



GARY AMENAG.PLAC. 400

301360 : L143 x H182 x P48cm,

Weight : 41kg ; Volume : 0.092m3;

Number of packages : 1

Dressing Kit / Kit verrière



✚ Treat yourself to the luxury of an organized dressing and a design that reflects your taste for modern industrial style with the KIT VERRIERE.

✚ Our dressing kit integrates all essential storage functions. With its adjustable width, shelves part, double hanging rail, shelves, and 2 drawers, each element is designed to simplify and organize your dressing space.

✚ The KIT VERRIERE guarantees closed storage with its workshop-style door and black curtain. Its black wardrobe bars add a contemporary and bold touch.

✚ The blend of **Dakota Oak** and **Black** creates an industrial atmosphere that will give your interior a remarkable identity. The mirror door in the style of a glass partition is the centerpiece, adding a touch of elegance and originality. The fusion of these elements creates a perfect balance between authenticity and modernity.



The products are made of particleboard, with a thickness of 15 mm.

The drawers are equipped with a ball-bearing slide system.

DAKOTA OAK

BLACK STIPPLE

Dressing Kit / Kit verrière



The industrial style dressing KIT VERRIERE includes:

- A shelves part with 5 shelves and 2 drawers
- A 2 black matte finish hanging rails
- A shelves part with a mirror door and 6 interior shelves
- A black curtain on a black matte lacquered tube



KIT DRESSING VERRIERE

300960 : L160 x H200 x P50cm,

Weight : 103.5kg ; Volume : 0.236m3;

Number of Packages : 4

Dressing / Modulix



✦ Discover Modulix, the dressing concept that redefines storage with its timeless design and modularity. Offering an infinite range of possibilities, Modulix adapts to your every need to create your ideal dressing room.

✦ With just four references, this dressing offers exceptional flexibility. Thanks to its ingenious design, the 83cm wide dressing can be positioned high or low, offering unparalleled layout flexibility. The 120cm wide dressing is reversible, adding extra versatility to adapt to your changing needs and space.

✦ Its flexibility adapts to the size of your room and your desires. Do you prefer an open dressing room or one hidden by a curtain, a large dressing or just a linen cupboard, with or without drawers? It's all possible!

✦ The subtle combination of its **White** bodies warmed by its **Oak** backgrounds and softened by its natural **Lin**en curtain creates a soothing, contemporary atmosphere. The **Black** details on the handles and wardrobe rails add a bold, trendy touch. Whatever your style, from classic to modern, Modulix adapts elegantly to any space, creating visual harmony.



The products are made in particleboard with a thickness of 15 mm

Drawers are fitted with ball bearing slides

WHITE

JACKSON OAK

Dressing / Modulix



The MODULIX contemporary modular dressing room includes:

- 83cm wide wardrobe module with 1 shelf and a multi-position bar
- A 120cm wide linen cupboard with 2 drawers and 4 shelves
- 83 cm curtain with bar and offset brackets
- A 120 cm curtain with bar and offset brackets



MODULE PENDERIE 83

303401 : L83 x H200 x P50cm, Weight : 33.8kg; Volume : 0.77m³; Number of packages: 1



RIDEAU 83 CM

303403 : L83 x H195 x P8cm, Weight : 0.69kg; Volume : 0.007m³; Number of packages: 1



MODULE LINGÈRE 120

303402 : L120x H200 x P50cm, Weight : 69.9kg; Volume : 0.146m³; Number of packages: 2



RIDEAU 120 CM

303404 : L120 x H195 x P8cm, Weight : 0.95kg; Volume : 0.010m³; Number of packages: 1

Dressing Kit / Play



✦ With PLAY, unleash your creativity, play with infinite arrangement possibilities, and personalize every detail for a dressing that evolves with you.

✦ The Play shelves push the limits of customization. With a span of up to 150 cm without separation, you can create unique spaces that perfectly suit your needs. The shelves, linen closets, and drawers offer maximum customization, allowing you to design a dressing that reflects you.

✦ The corner module of Play is the perfect ally for optimizing space. Place it perpendicularly to an interior to utilize every corner, thus maximizing the use of your dressing. This ingenious functionality offers great freedom of arrangement while maintaining visual harmony.

✦ Its **Jackson Oak** color and sleek, contemporary design harmonize perfectly with any interior. The reversible **Black** or **White** back panels add an aesthetic dimension, allowing you to customize the visual aspect of your dressing and perfectly match the brushed champagne metal handles. With Play, style meets functionality to create a space that inspires you.



The products are made of particleboard, with a thickness of 18 mm.

The drawers are equipped with a ball-bearing slide system.

JACKSON OAK

BLACK STIPPLE

WHITE

Dressing Kit / Play



The PLAY dressing includes :

- Finishing sides and connecting side
- Interiors of 60, 90, 120, and 150 cm, respectively 56 cm, 86 cm, 116 cm, and 144 cm in width
- Reversible Black/White 3 mm HDF backs
- 3 shelves in 37 mm honeycomb panel and 1 shelf of 18 mm thickness on plinth
- 1 Wardrobe bar with 2 supports, plus an intermediate support for 120 and 150 cm interiors
- Corner kit: to be placed perpendicularly to an interior
- Drawer blocks 60 and 90: drawer in panel on invisible full-extension slide
- Linen closet 60: 3 shelves to be integrated into a 90/120/150 interior
- Set of 2 shelves 60 and 90: to be integrated into a 60 or 90 interior or placed next to the linen closet

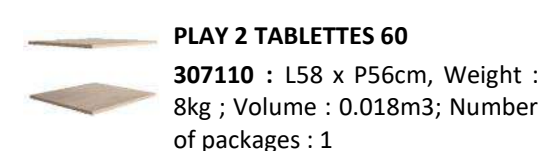
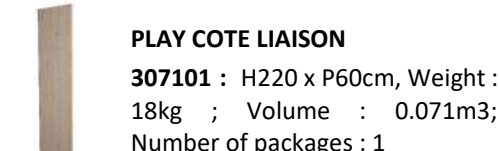
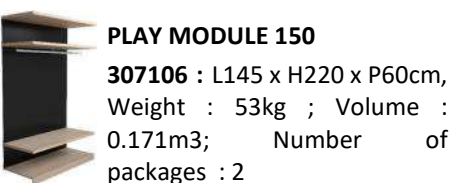
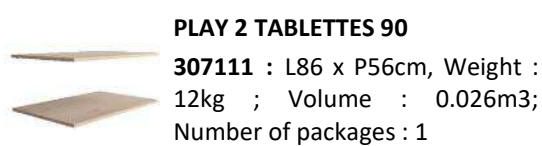
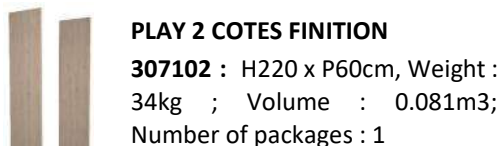
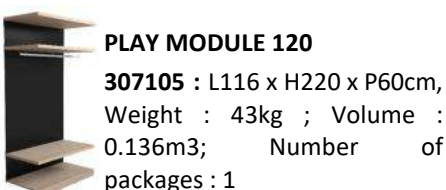
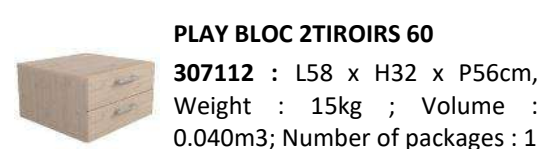
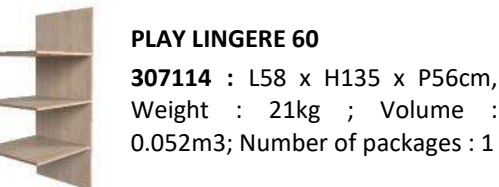
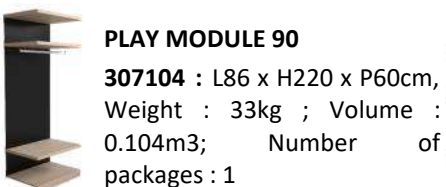
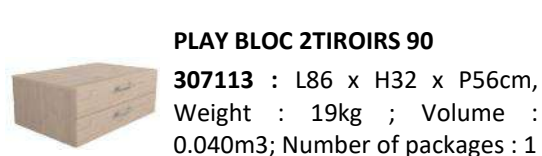
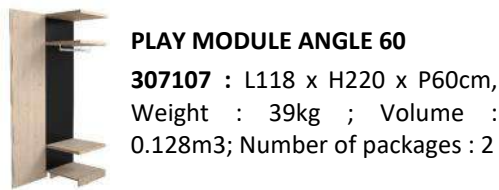
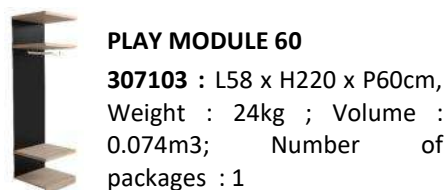

Dressing Kit / Prima



✦ Discover our ingenious PRIMA dressing, designed to simplify your daily routine while bringing a modern touch to your space!

✦ Our dressing features a unique rod that, on one side, is attached to a shelves part with 3 shelves, offering structured and accessible storage space. On the other side, it attaches to the wall, optimizing space usage while ensuring maximum stability. This intelligent design allows for impeccable organization of your clothes.

✦ Combine two PRIMA elements to get a solution with 2 shelves parts and 2 wardrobes with its removable hanging rails !

✦ Opt for the purity of **White** with our simple dressing. Its sleek and minimalist design adds a touch of modernity to any space, harmoniously integrating into your existing decor. The minimalist style allows the wardrobe to adapt to different environments, creating a fresh and calming atmosphere.



The products are made of particleboard, with a thickness of 15 mm.

WHITE



The ingenious PRIMA dressing includes:

- An hanging rail attached on one side to the linen closet and on the other to the wall, or combine 2 elements to fix it to the second linen closet
- A shelves parts with 3 shelves



PRIMA BLANC AME.PLA

300140 : L138 x H180 x P40cm, Weight : 21kg ; Volume : 0.054m³; Number of packages : 1

Dressing Kit / Sous-comble



✦ Discover the SOUS-COMBLE, the ideal solution to optimize your storage space under the eaves with practical features and a universal style.

✦ Maximize your space with this design, perfectly suited for integration under the roof slopes. Its compact and intelligent design allows you to make the best use of every available centimeter.

✦ Organize your clothes efficiently with the linen space equipped with two spacious shelves. The 97 cm long hanging rail provides additional space to hang your clothes, thus maximizing storage capacity.

✦ The universal **White** decor of the Sous-comble adapts to all interior styles, adding a touch of simplicity and elegance to your space.



The products are made of particleboard, with a thickness of 15 mm.

WHITE

Dressing Kit / Sous-comble



The SOUS-COMBLE dressing includes :

- **Shelves parts** : Two shelves for organized storage of your clothes and accessories.
- **Wardrobe** : 97 cm long hanging rail to hang your clothes.
- **Adapted design** : Angled sides for easy integration under roof slopes.

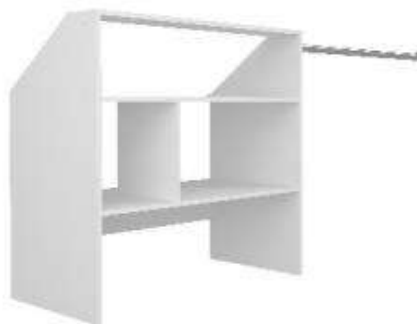

AMENAG.SOUS COMBLES

300910 : L197 x H97 x P50cm, Weight : 25kg ; Volume : 0.058m³; Number of packages : 1

Dressing Kit / Tango



✦ TANGO, the dressing that combines large storage capacity with a customizable style. Redefine your space with this essential storage solution.

✦ Tango offers a spacious and ingenious storage solution. The two 60 cm columns have 5 shelves and a drawer, providing organized space for your clothes, shoes, and accessories. The wardrobe spaces with a winter shelf and 2 hanging rails add optimal functionality for hanging your clothes.

✦ Let your creativity run free with Tango. The full-height reversible Black or White backs allow you to personalize the style of your dressing, adding a contemporary touch to your space.

✦ Its very contemporary style, whether in **Brooklyn Oak & Black** or **Brooklyn Oak & White** mix decor, brings a modern and trendy touch to your space. The reversible backs offer aesthetic flexibility, allowing you to customize your wardrobe according to your tastes and the changes in your decor.

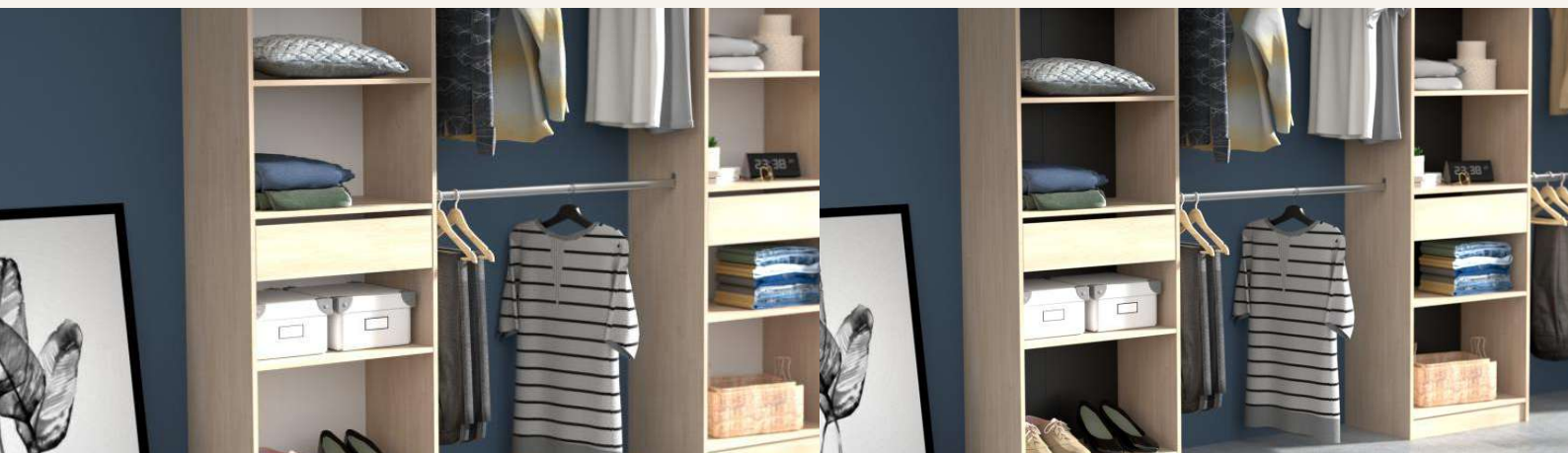

The products are made of particleboard, with a thickness of 15 mm.

The drawers are equipped with ball-bearing systems.

BROOKLYN OAK

WHITE

BLACK

Dressing Kit / Tango



The dressing with reversible color TANGO includes:

- 60 cm wide columns: 5 shelves and a drawer, full-height reversible Black or White back
- 100 cm wide wardrobe spaces: winter shelf
- 2 hanging rails



TANGO AMEN.PLA CH.BRO

300010 : L320 x H200 x P40cm, Weight : 81kg ; Volume : 0.160m³; Number of packages : 2



DESKS

DESK / Begin



✚ A reversible and compact corner desk with **plenty of storage spaces** : drawer, shelves, storage compartments and a shaped extension.

✚ With this desk you can store all your essentials and organise your workspace.

✚ Begin is a trendy industrial style desk in **Brooklyn Oak** contrasting with the interior storage and Black Stipple handle giving it character and depth.



9873BUAN : L121 x H102 x P106
Weight : 40 kg - Volume : 0,078m3
Number of packages : 2

DESK / Escale



✚ The Escale range is expanding with a Japandi-style desk!

✚ The Escale desk has a clerestory-style credenza with cable management and 3 removable storage shelves when the desk is assembled, offering 6 possible positions for your storage essentials. The 60cm of space between the shelves can accommodate a large computer screen. Underneath its wide 138cm worktop are 2 niches and a drawer for storing your files or multimedia devices.

✚ Its **Japanese Oak** creates a relaxing, natural atmosphere and will blend in perfectly with all the other elements in your adult and children's bedroom!



3580BURE : L138 x H120 x D60cm;
Weight : 41kg ; Volume : 0,086m3;
Number of packages : 2

DESK / Gaming



➤ Designed for **gamers**, this innovative desk is equipped with an extension that can hold multiple screens and an audio system

➤ Enjoy a large play area with an optical mouse-compatible surface for greater **freedom of movement**

➤ This desk also has an open space dedicated to the storage of a central unit, a storage space closed by a door and a headset holder

➤ Recreate the atmosphere of the greatest competitions with the **LED kit** with remote control included



The products are made of particleboards with a thickness of 15 and 22 mm

BLACK STIPPLE



The **GAMING** desk, designed to set up a play station includes :

- A 152 cm long x 62 cm deep gaming area with a 19 cm deep overhang that can accommodate multiple screens and an audio system
- A closed storage space (with a shelf) of 52 cm high x 40 cm deep
- An open space of 60 cm deep x 39 cm width dedicated to the storage of a central unit
- A second open space of 17 cm high located under the space dedicated to the central unit

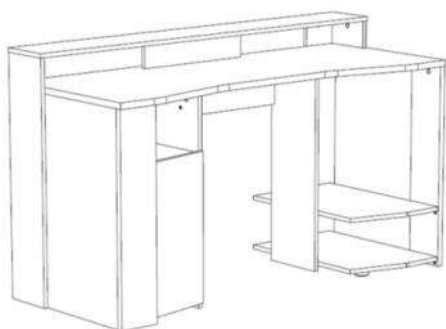

6940STAT : L152 x H87 x D62
Weight : 46 kg - Volume : 0,101m3
Number of packages : 2

DESK / Infinity



✦ Functional and space-saving, the Infinity desk has a large top measuring 121 cm long x 55 cm deep and a large storage capacity with three 14 cm high drawers

✦ Choose your style with its 3 versions : **Light Acacia** for a warm atmosphere, **White** to bring luminosity or **Brooklyn Oak** and **Black Stipple** for a trendy industrial look or **White** and **Brooklyn Oak** for a soft natural look. This functional desk is ideal to create a work space at home !



The products are made of particleboard, with a thickness of 15 mm

The drawers are equipped with a ball bearing runner system

LIGHT ACACIA

WHITE

BROOKLYN OAK

WHITE

BLACK STIPPLE

BROOKLYN OAK
181

DESK / Infinity



The timeless **INFINITY** desk includes:

- A 121 cm long and 55 cm deep desk
- 3 drawers measuring 35 cm long and 31 cm deep
- 3 grey handles for the Acacia and White versions.
- 3 black handles for the Oak / Black version.
- 3 white handles for the White / Oak version.



Dimensions : L121 x H74 x P55

weight : 26 kg - Volume : 0,055m³

6193BUR1-ECR : Light Acacia

6493BUR1-ECR : White

6439BURE : Brooklyn Oak / Black Stipple

6440BURE : White / Brooklyn Oak

DESK / Level



✦ Create your atmosphere with the LEVEL Led kit desks

✦ This spacious gaming desk has a large surface area of 150 cm in length with a hutch that can accommodate two screens and a sound system to give you total immersion

✦ This desk is also equipped with a compartment for a central unit, a sliding shelf with carbon finish handle and an open storage space under the desk

✦ Choose the **Black Stipple** version for total immersion in the world of gaming.



BLACK STIPPLE

The products are made of particleboards with a thickness of 15 and 22 mm
The sliding shelf is equipped with a metal roller runner system



The immersive gaming desk LEVEL includes :

- A 150 cm long x 58 cm deep gaming area with a shaped hutch that can accommodate multiple screens and a sound system
- A 70 cm high open storage area under the desk with a mid-height shelf
- A compartment for a central unit
- A sliding shelf with a carbon finish handle ideal for storing controllers or using as a secondary platform
- A LED kit with remote control included

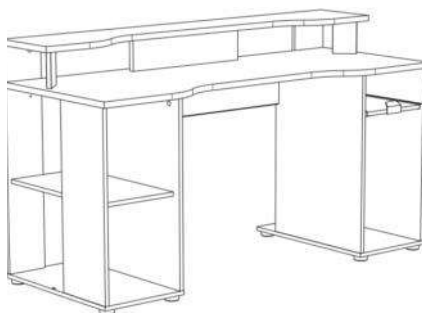

6900STAT : L150 x H90 x P60; Weight : 42 kg - Volume : 0,099m3; Number of packages : 2

FILING CABINET / Milo



✦ A range of three and four drawer file and document cabinets with generous storage capacities

✦ The drawers are equipped with metal rods to hang your files. The top drawer is also equipped with a key lock

✦ These filing cabinets with Japanese Oak fronts have White or Black Stipple surrounds and handles for a soft, natural atmosphere



Dimensions : L44 x H106 x D40
Weight : 24 kg - Volume : 0,05m³
7424CLAS : White | Japanese Oak version
7426CLAS : Black Stipple | Japanese Oak version



Dimensions : L44 x H138 x D40
Weight : 31 kg - Volume : 0,064m³
7425CLAS : White | Japanese Oak version
7427CLAS : Black Stipple | Japanese Oak version

The products are made of particleboards with a thickness of 15 mm

The drawers are equipped with a roller runner system

JAPANESE OAK

WHITE

JAPANESE OAK

BLACK STIPPLE

DESK / Minister



✚ A real "Minister's" desk designed to work, store and classify with a 22 mm thick desk, various closed storage units, a locked drawer and an additional open storage space under the desk

✚ A 77 cm high extension is also available as an option, including a 43 cm shelf and a 107 cm long storage niche with sliding door



9872BURE : L152 x H78 x D59
Weight : 48 kg - Volume : 0,098m3
Number of packages : 2



9872REHA : L151 x H77 x D28
Weight : 21 kg - Volume : 0,047m3

The products are made of particleboards with a thickness of 15 and 22 mm
The drawers are equipped with a ball-bearing runner system

ARTISAN OAK

DESK / Mister



✦ A very functional desk with a large ergonomic surface and a **side bookcase**

✦ Space-saving, this **2-in-1** furniture is ideal to furnish a small room, a student's studio or to create a workspace in your living room

✦ Brighten up your home with this modern styled library desk in an elegant, timeless **white** !

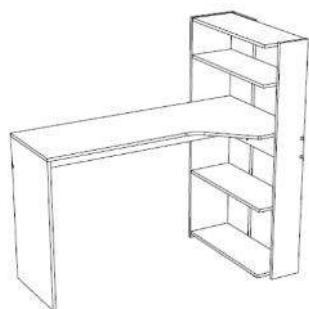

7419BURE : L122 x H121 x D64
Weight : 28 kg - Volume : 0,056m³

WHITE

The products are made of particleboards with a thickness of 15 mm

DESK / Paloma



✦ Design and trendy, discover Paloma and create a soothing, natural workspace.

✦ A desk with large storage space. 60 cm deep and equipped with a riser and drawer, the Paloma desk is very comfortable to use.

✦ Inspired by the Japandi trend, with clean lines, this collection in **Japanese Oak | Shiny White** includes a claustra creating luminous atmosphere.

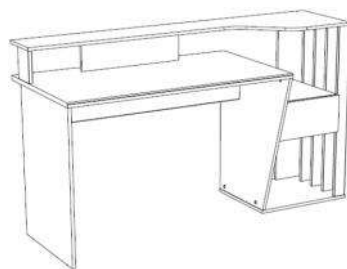

9914BURE : L157 x H92 x D60;
Weight : 37 kg - Volume :
0,089m³; Number of packages : 2

The products are made of particleboards with a thickness of 15 and 22 mm

The drawers are equipped with a roller runner system

JAPANESE OAK

SHINY WHITE

DESK / Set-Up



✦ Co-developed with the Webedia multimedia group, the Set-Up collection includes gaming desk with melamine covering that combine **ergonomics and functionality**

✦ Beautiful desk with spacious areas and numerous storage spaces enhanced with accessories (helmet hook, LED ribbon with remote control...) for maximum comfort

✦ An offer dedicated to players, whether they are novices or experienced, for a game in total immersion !



The products are made of particleboards with a thickness of 15 and 22 mm

The drawers are equipped with a roller runner system

DARK GREY

DESK / Set-Up



The **SET-UP** collection, designed to offer maximum comfort, includes :

- A 180 cm long desk which can accommodate 3 screens
- Carbon finish handles and remote controlled LED kit
- Remote controlled LED kit

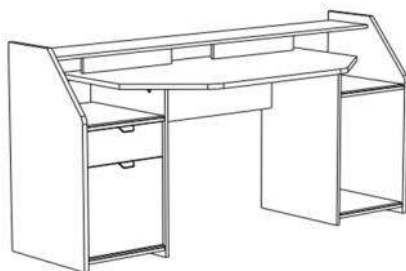

7540STAT : L180 x H92 x D67
Weight : 56 kg - Volume : 0,125m³
Number of packages : 2

DESK / Silver



✚ Silver is an attractive and practical 180cm long desk. It offers a wide desk top, a top for 3 screens, open niches, a storage for the central unit, as well as a drawer and a door to store your work or gaming equipment.

✚ The **Japanese Oak** and **Shiny White** colours make it modern and contemporary. The Shiny White reflects the LEDs fixed under the top, making the desk look bright. The original cut-outs make Silver a unique desk, suitable for a living room as well as a bedroom.

✚ The desk has an RGB LED strip whose colour and intensity can be chosen with a remote control. This practical LED strip removes the need for additional lighting and allows you to personalise your work or play space with your favourite colour.



The products are made of particle board, with a thickness of 15 and 22 mm

SHINY WHITE

JAPANESE OAK

The drawers are equipped with a roller runner system

DESK / Silver



The elegant **SILVER** Desk includes:

- A 178 cm long desk with a large top, a top for 3 screens, a drawer and a door.
- RGB LED strip with remote control
- Space dedicated to the central unit



6890STAT : L. : 178 cm - H. : 88 cm - D. : 68 cm, Weight : 49kg; Volume : 0.108m³, Number of packages : 2

DESK / Start Up



✦ A range of **modular and robust desks** and **bookcases** to meet all furnishing

✦ Options thought for today's uses (corner units to join desks together, cable management, locks ...)

✦ A very contemporary style with a mix of **Artisan Oak** and **shadow Grey** decors, highlighted by metal legs and Aluminium Grey coloured handles

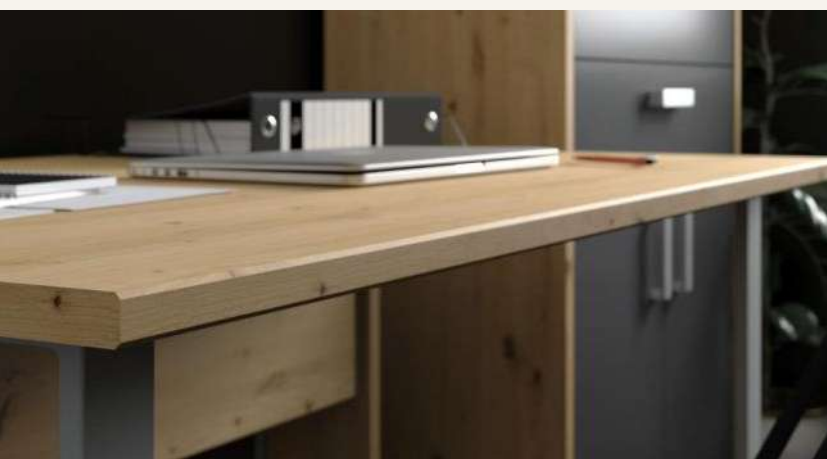

The products are made in particleboard, with a thickness of 15 mm and 22 mm

Drawers are equipped with a roller runner system

ARTISAN OAK

SHADOW GREY

DESK / Start Up



The START UP modular desk and bookcase collection includes :

- Three desks with lengths of 120, 150 and 180 cm
- One corner to join two desks together without additional legs
- A desk with swivelling storage unit on wheels, cable management and a lock
- A three drawers unit with wheels and a lock
- Three bookcases with heights of 107, 175 and 210 cm
- A set of two bookcase doors with lock (one of which has two drawers)
- Two filing cabinets of 3 and 4 drawers with a lock



7958BU12 : L120 x H73 x D80 | Weight : 33 kg - Volume : 0.129m3 | Number of Packages : 2



7958BU15 : L150 x H73 x D80 | Weight : 38 kg - Volume : 0.141m3 | Number of Packages : 2

7958BU18 : L180 x H73 x D80 | Weight : 43 kg - Volume : 0.154m3 | Number of Packages : 2

7959CAIS : L49 x H70 x D49
Weight : 24 kg - Volume : 0,061m3



7962BIBL : L82 x H175 x D41; Weight : 51 kg - Volume : 0,094m3



7964PORP : L78 x H100 x D1,5; Weight : 9 kg - Volume : 0,029m3



7958ANGL : L80 x H2,2 x D80; Weight : 8 kg - Volume : 0,022m3



7965CLAS : L44,3 x H138,4 x D40,3
Weight : 31 kg - Volume : 0,064m3



7966CLAS : L44,3 x H106,4 x D40,3
Weight : 24 kg - Volume : 0,050m3



7961BIBL : L83 x H107 x D41
Weight : 32 kg - Volume : 0,066m3



7963BIBL : L82 x H209 x D41; Weight : 59 kg - Volume : 0,110m3; Number of Packages : 2



7964POTI : L78 x H100 x D37
Weight : 14 kg - Volume : 0,028m3



BEAUTY BARS



✦ Discover a timeless and beautiful dressing table with **Precious** and dress up your wall while creating a relaxing space just for you!

✦ With its corner shelves, the dressing table offers storage space for all your beauty products while keeping your space visually neat. Its drawer has 4 compartments for organising your make-up or nail varnish.

✦ Designed to fit in with your daily routines, this dressing table includes a large mirror for effortless grooming.

✦ Combining the warm tones of **Jackson Oak** with the luminosity of **White**, the Precious dressing table brings a sleek, modern touch to any bedroom or beauty area. .

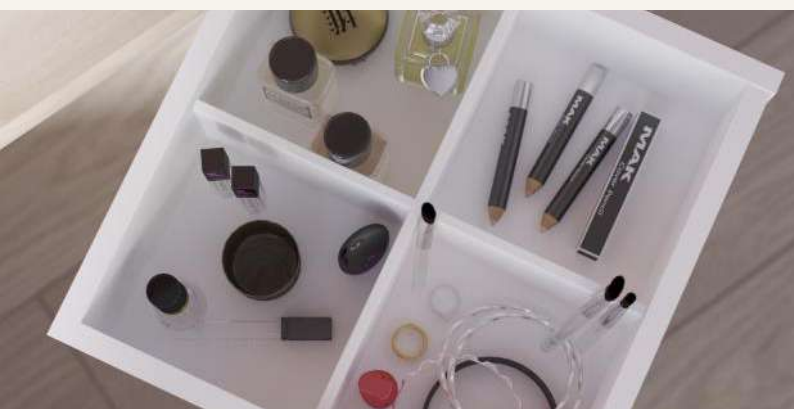

The product are made in particle board, with a thickness of 15 and 22 mm

JACKSON OAK

WHITE

BEAUTY BAR / Precious



The cosy PRECIOUS Beauty Bar includes:

- A 62 cm high mirror
- A 28 cm deep drawer that swivels through 135°. Includes 4 compartments.
- 2 corner shelves 31cm long and 17cm deep

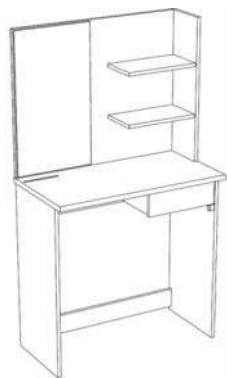

7630COIF : L75 x H141 x P40cm; Weight : 22kg - Volume : 0.047m³; Number of packages : 1



✚ Furnish your room with real movie theater-style furniture with our **SWEET** and **VOLAGE** dressing tables! These beautiful corner furniture available in **White** and **White | Jackson Oak** will definitely find their place in your room

✚ Don't miss any more functionality with these innovative dressing tables equipped with 3 mirrors (including a central mirror illuminated by the included LED kit), a mobile/tablet support, several shelves as well as 5 drawers swiveling at



WHITE WHITE

JACKSON OAK

The dressing tables are made of particleboards with a thickness of 15 and 22 mm

BEAUTY BAR / Volage



Dimensions : L114 x H142 x D61

Weight : 38 kg - Number of packages : 2

7365COIF : White version - Volume : 0,078m3

7385COIF-ERC : White | Jackson Oak version - Volume : 0,091m3



KITCHENS

Kitchen / Anna



✦ Anna, the black oak kitchen that combines modularity with timeless elegance.

✦ With 13 top and base units available in lengths of 40, 60 and 80 cm, the Anna kitchen is highly modular. Configure it to suit your needs.

✦ Whether you're looking for a small, compact kitchen or a generous installation, Anna adapts perfectly to your needs.

✦ **Cabezone Oak** adds a contemporary and elegant touch, illuminated by a **White Stone** worktop that is both fashionable and functional. This colourful combination contrasts harmoniously with the luminosity and robustness of the stone and the sobriety of the black oak, creating a kitchen that is as attractive as it is practical.

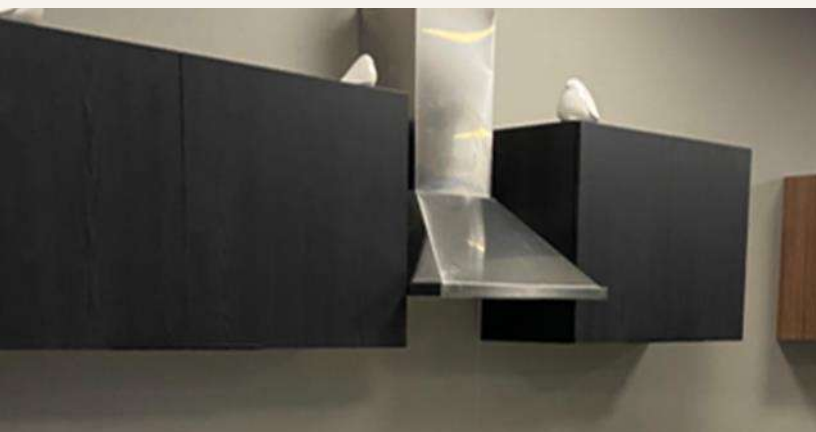

*The products are made in particle board with a thickness of 15, 16 and 22mm
Drawers are fitted with ball bearing runner systems*

CABEZONE OAK

WHITE STONE



Our ANNA Cabezone oak kitchen includes :

4 top unit (Height 60 x Depth 36 cm)

- Top Unit L40 1 door / Top Unit L60 1 door / Top Unit L80 2 doors
- Short top unit L60 1 door (35 cm high)

8 base unit (Height 86.6 x Depth 60 cm)

- Base unit L40 1 door / Base unit L40 1 door + 1 drawer
- Base unit L60 1 door / Base unit L60 1 door + 1 drawer
- Base unit L60 oven / Base unit L60 3 drawers
- Base unit L80 2 doors / Base unit L100 Angle 1 door + 1 threader

1 Storage (Height 209 x Depth 58 cm)

- Storage L60 2 doors for oven and microwave integration

- 100% one-box kitchen: Worktop and base included for quick and easy installation
- New units available in the ONE BOX range: 60 oven & micro oven & 100 base unit
- Doors and drawers fitted with shock absorbers for smooth, silent closing
- 22 mm thick worktop in White Stone decor
- Fronts and shelves 'full decor' 2-sided Black Oak
- Fronts with thick ABS edge in Black Oak decor
- Black lacquered aluminium profile handle
- Base units with crossbars for attaching a linear worktop of the customer's choice (to be purchased separately)
- Base units and cupboard fitted with 4 adjustable glides



0432HA40 : L40 x H58x D36cm;
Weight : 11kg - Volume :
0.024m3; Number of packages : 1



0432BP60 : L60 x H87x D60cm;
Weight : 28kg - Volume :
0.063m3; Number of packages : 1



0432BAFO : L60 x H87 x D60cm;
Weight : 21kg - Volume :
0.064m3; Number of packages : 1



0432HA60 : L60 x H58x D37cm;
Weight : 14kg - Volume :
0.036m3; Number of packages : 1



0432BP80 : L80 x H87 x D60cm;
Weight : 33kg - Volume :
0.079m3; Number of packages : 1



0432BANG : L100 x H87x D60cm;
Weight : 33kg - Volume :
0.085m3; Number of packages : 1



0432HA80 : L80 x H58x D36cm;
Weight : 18kg - Volume :
0.038m3; Number of packages : 1



0432BA40 : L40 x H87 x D60cm;
Weight : 24kg - Volume :
0.063m3; Number of packages : 1



0432ARFO : L60 x H209x D58cm;
Weight : 56kg - Volume :
0.128m3; Number of packages : 2



0432HC60 : L60 x H35x D36cm;
Weight : 12kg - Volume :
0.024m3; Number of packages : 1



0432BA60 : L60 x H87x D60cm;
Weight : 31kg - Volume :
0.074m3; Number of packages : 1



0432BP40 : L40 x H87x D60cm;
Weight : 22kg - Volume :
0.055m3; Number of packages : 1



0432BT60 : L60 x H87x D60cm;
Weight : 31kg - Volume :
0.074m3; Number of packages : 1



✦ Furnish your kitchen with our BRUNCH high table, the perfect solution seamlessly combining smart storage and a snack counter, making this island the centerpiece of your kitchen, blending practicality and style.

✦ Our high table offers five well-thought-out storage spaces, providing generous room to organize all your kitchen utensils and ingredients. The versatility of these five spaces facilitates storage while maintaining maximum accessibility to all your culinary needs.

✦ The metal legs of the high table are the perfect combination of strength and lightness. They provide a robust base while giving a visually light aesthetic. This combination offers optimal functionality while adding a touch of elegance to your kitchen.

✦ The contrast between bold **Black** and **Jackson Oak** brings a modern and warm dimension to your culinary space. The black lacquered metal legs not only add visual lightness but also reliable strength, creating a contemporary and robust aesthetic.



The products are made of particleboard, with a thickness of 15 and 22 mm.

BLACK STIPPLE

JACKSON OAK



The industrial-style high table BRUNCH includes :

- 22 mm thick worktop, for a substantial appearance
- Black lacquered metal legs: providing both visual lightness and good resistance
- 5 storage spaces, with 2 height-adjustable shelves



ILOT BRUNCH

803346 : L110 x H90 x P80cm, Weight : 38kg ; Volume : 0.100m³; Number of packages : 1



✦ Add a charming, rustic feel to your kitchen with the COTTAGE range.

✦ The cupboard from the Cottage range offers generous space for storing your utensils, crockery and other kitchen accessories. With its open niches and cross-shaped bottle holder, this cupboard lets you keep your groceries organised and within easy reach. The door has 3 extra shelves for even more versatile storage.

✦ The sideboard features a practical drawer, a door with an internal shelf and an open niche, providing flexible storage space for a variety of kitchen items. The lower niche has a cross-shaped bottle rack, adding a touch of rustic charm to your decor.

✦ The **White** and **Jackson Oak** colours creates a warm and welcoming look, perfect for creating a convivial atmosphere in your living space. The frame and shell handles add a touch of traditional character, evoking the timeless charm of country kitchens.



The products are made in particleboard with a thickness of from 15 mm.

JACKSON OAK

WHITE



The rustic COTTAGE range includes :

- Cupboard : 1 high shelf, 1 hinged door containing 3 shelves, 3 open niches and a cross-shaped space designed to store bottles. 1 metal handle.
- Sideboard: One hinged door with 1 interior shelf, one drawer, one open niche and one bottle holder. 2 metal handles.



1-DOOR HIGH CUPBOARD
3435 : L94 x H185 x D43cm,
 Weight: 69kg; Volume: 0.189m³;
 Number of packages: 2



SIDEBOARD 1 DOOR 1 DRAWER
803343 : L110 x H91 x D43cm,
 Weight : 38kg ; Volume : 0.092m³;
 Number of packages: 2



✦ Make your EKO kitchen a reflection of your personality with our modular kitchen range, where creativity and functionality meet. This modular collection offers a lot of compositions to imagine a kitchen that resembles you.

✦ Designed to fit all configurations, this range offers a custom solution for every corner of your kitchen. Maximize the efficiency of your space by choosing the elements that match your lifestyle.

✦ Evolve with your kitchen. Whether you need to add extra storage, optimize the layout, or meet new needs, our modular range easily adapts to the evolution of your daily life.

✦ Harmonize your kitchen with your preferred aesthetic by choosing from our three elegant colours : the pure minimalism of **White**, the warmth of **Jackson Oak**, and the modernity of **Shinny Grey**. Each colour adds a distinctive touch to your space, creating a kitchen that combines style and functionality with timeless elegance.



WHITE

JACKSON OAK

SHINNY GREY

*The products are made of particleboard, with a thickness of 16mm.
The drawers feature ball-bearing slides, and the deep drawers have roller slides.*



The timeless and modular kitchen elements EKO include :

- Top unit height 58cm or 35cm and depth 36cm
- Base unit height 86cm and depth 60cm
- Column height 140cm and depth 60cm
- Worktop and base included in the packages
- Large handles with 160mm center-to-center distance
- Base unit with adjustable feet



HT40 H58 H 4
L40 x H58 x P36cm; Weight : 12kg -
Volume : 0.026m³; Packages : 1
WHITE : **244001**
JACKSON OAK : **244301**
SHINNY GREY : **244201**



B60 1P P60 B 6
L60 x H86 x P60cm; Weight : 28.5kg -
Volume : 0.066m³; Packages : 1
WHITE : **244011**
JACKSON OAK : **244311**
SHINNY GREY : **244211**



B80 2P P60 B 8
L80 x H86 x P60cm; Weight : 31kg -
Volume : 0.079m³; Packages : 1
WHITE : **244044**
JACKSON OAK : **244344**
SHINNY GREY : **244244**



HT60 H58 H 6
L60 x H58 x P36cm; Weight : 15kg -
Volume : 0.039m³; Packages : 1
WHITE : **244002**
JACKSON OAK : **244302**
SHINNY GREY : **244202**



B60 1T2TC P6 B 6
L60 x H86 x P60cm; Weight : 31kg -
Volume : 0.075m³; Packages : 1
WHITE : **244012**
JACKSON OAK : **244312**
SHINNY GREY : **244212**



B60 FOUR P60 F60
L60 x H86 x P60cm; Weight : 25kg -
Volume : 0.064m³; Packages : 1
WHITE : **244043**
JACKSON OAK : **244343**
SHINNY GREY : **244244**



HT80 H58 H 8
L80 x H58 x P36cm; Weight : 19kg -
Volume : 0.041m³; Packages : 1
WHITE : **244003**
JACKSON OAK : **244303**
SHINNY GREY : **244203**



B80 2T2P P60 B 8
L80 x H86 x P60cm; Weight : 41kg -
Volume : 0.079m³; Packages : 1
WHITE : **244014**
JACKSON OAK : **244314**
SHINNY GREY : **244214**



HT CT60 H35
L60 x H36 x P36cm; Weight : 10kg -
Volume : 0.024; Packages : 1
WHITE : **244005**
JACKSON OAK : **244305**
SHINNY GREY : **244205**



B40 1T1P P60 B 4
L40 x H86 x P60cm; Weight : 25kg -
Volume : 0.063m³; Packages : 1
WHITE : **244009**
JACKSON OAK : **244309**
SHINNY GREY : **244209**



1/2 ARM60 IFR
L60 x H141 x P60cm; Weight : 45kg -
Volume : 0.098m³; Packages : 1
WHITE : **244049**
JACKSON OAK : **244349**
SHINNY GREY : **244249**

Kitchen — Single Unit / Essentiel



✦ Discover the essence of efficiency and universal style with our collection of 12 single units ESSENTIEL, a range that redefines simplicity and functionality.

✦ Our single single units are designed for optimal use of space, offering compact storage with essential functions. Whether it's microwave racks, kitchen trolleys or cupboard, each piece is designed to make your daily life easier, offering a practical and functional solution.

✦ Practicality is highlighted with freestanding furniture that requires no complex installation. Multifunctional wheels add welcome mobility, allowing you to reconfigure your space at will. These pieces adapt to your dynamic life with remarkable ease.

✦ Elegant simplicity with the Essentiel range available in three distinct colours: **White, Shiny Grey, and Jackson Oak**. The contemporary and universal design of each piece of furniture will perfectly match the EKO kitchen range.



WHITE

JACKSON OAK

SHINNY GREY

*The products are made of particleboard, with a thickness of 16mm.
The drawers are equipped with ball-bearing and roller systems.*



The timeless single kitchen units ESSENTIEL includes:

- Microwave racks, kitchen trolleys, combined units, and cupboards.
- 120 cupboard and microwave kitchen trolley available in 3 finishes
- Freestanding furniture, easy to assemble and install
- Matte chrome decorative handle
- Large storage niches can accommodate a microwave or other appliances
- Multidirectional wheels on kitchen trolleys



BUFFET 120 ESSEN

L120 x H185 x P40cm; Weight : 61kg -
Volume : 0.139m³; Packages : 2

WHITE : 3406

JACKSON OAK : 3407

SHINNY GREY : 3408



BUFFET ESSENTIEL 101 BLANC

3377 : L101 x H185 x P40cm; Weight :
51kg - Volume : 0.115m³; Packages : 2



ESSENTIEL 80 BLANC

3241 : L80 x H181 x P44cm; Weight : 47kg
- Volume : 0.113m³; Packages : 1



DESSERTTE ESSENTIEL 60 BLANC

803339 : L60 x H116 x P40cm; Weight :
25kg - Volume : 0.065m³; Packages : 1



DESSERTTE ESSENTIEL

L60x H81 x P44cm; Weight : 22kg - Volume :
0.058m³; Packages : 1

WHITE : 803219

JACKSON OAK : 803347

SHINNY GREY : 803348



COMBI ESSENTIEL 101 BLANC

803341 : L101 x H127 x P40cm; Weight :
41kg - Volume : 0.096m³; Packages : 1



RACK M.O ESSENTIEL 76 BLANC

803192 : L76 x H81 x P41cm; Weight : 26kg
- Volume : 0.054m³; Packages : 1



RACK M.O ESSENTIEL 60 BLANC

803191 : L60 x H81 x P40cm; Weight : 19kg
- Volume : 0.046m³; Packages : 1

Kitchen / Fumay



✚ Choose FUMAY, a kitchen that reflects your lifestyle and personality, combining warmth and modernity. An innovative kitchen that will transform your culinary space into a unique place!

✚ Our design incorporates a dedicated space for each utensil. With 13 elements to choose from, you can organise your oven, saucepans and provisions perfectly.

✚ From wall units to base units, FUMAY gives you the opportunity to design your living space with the elements available in the range.

✚ The warm aesthetics of the **Rought Oak** décor merge with the sturdiness of the **Dark Concrete** décor worktop to create a kitchen with character. Also available in this range : FUMAY cupboard and sideboard



*The products are made in particleboard with a thickness of 16mm and 22mm
Ball bearing slides on drawers and roller bearing slides on pot-and-pan drawers.*

ROUGHT OAK

DARK CONCRETE



FUMAY's traditional, industrial-style kitchen includes :

- High units 58cm or 35cm high and 36cm deep
- Base units 86cm high and 60cm deep
- Central island 109cm wide, 90cm high and 80cm deep
- Column 60cm wide, 140cm high and 60cm deep
- Worktop and plinth included in packages
- Matt black lacquered aluminium handles
- Base units with adjustable glides



FUMAY H58 H 4

246501 : L40 x H58 x D36cm;
Weight : 12kg - Volume : 0.026m3;
Number of Packages : 1



FUMAY H58 H 6

246502 : L60 x H58 x D36cm;
Weight : 15kg - Volume : 0.039m3;
Number of Packages : 1



FUMAY H58 H 8

246503 : L80 x H58 x D36cm;
Weight : 19kg - Volume : 0.041m3;
Number of Packages : 1



FUMAY H35 H06

246505 : L60 x H36 x D36cm;
Weight : 10kg - Volume : 0.024;
Number of Packages : 1



FUMAY NICHE H80 H 4

246507 : L60 x H36 x D36cm;
Weight : 12kg - Volume : 0.026;
Number of Packages : 1



FUMAY 1T1P P60 B 4

246509 : L40 x H86 x D60cm;
Weight : 25kg - Volume : 0.063m3;
Number of Packages : 1



FUMAY 1T2TC 60

246512 : L60 x H86 x D60cm;
Poids : 31kg - Volume : 0.075m3;
Number of Packages : 1



FUMAY 2P P60 B 8

246544 : L80 x H86 x D60cm;
Weight : 35kg - Volume : 0.079m3;
Number of Packages : 1



FUMAY 2T2P P60 B 8

246514 : L80 x H86 x D60cm;
Weight : 41kg - Volume : 0.079m3;
Number of Packages : 1



FUMAY 1P P60 B 6

246513 : L60 x H86 x D60cm;
Weight : 28kg - Volume : 0.066m3;
Number of Packages : 1



ILOT FUMAY

803370 : L109 x H90 x D80cm;
Weight : 389kg - Volume : 0.100m3;
Number of Packages : 1



FUMAY P60 F60

246543 : L60 x H86 x D60cm;
Weight : 22kg - Volume : 0.055m3;
Number of Packages : 1



FUMAY 1/2ARM.FOU

246539 : L60 x H141 x D60cm;
Weight : 39kg - Volume : 0.084m3;
Number of Packages : 1



✦ Add storage to your kitchen with our FUMAY range of complementary furniture and transform your cooking area into a place that's both functional and attractive.

✦ Fumay offers a clever combination of open and closed storage. The sideboard has 2 doors, 1 drawer, 1 saucepan drawer and 4 open niches to organise your utensils and crockery efficiently, while adding a touch of variety to your kitchen décor.

✦ The sideboard includes 2 doors, 1 open niche and 2 side spaces for storing your bottles, offering a practical solution for storing your favourite drinks.

✦ Give your kitchen a contemporary, authentic look with our range of complementary furniture. The combination of **Rought Oak** and **Dark Concrete** creates an aesthetic that evokes contemporary authenticity. Fumay is the perfect complement to the kitchen of the same name.



The products are made in particleboard with a thickness of from 15 mm.

The drawers are fitted with ball bearing and roller runner systems

ROUGHT OAK

DARK CONCRETE



Authentic FUMAY kitchen storage includes:

- Cupboard 100 : 2 doors, 1 drawer, 1 casserole drawer, 4 open niches. Cable management integrated into the central niche, credenza profile at the back of the central niche. Belt and drawer bottom in black decor.
- Cupboard 75 : 2 doors, 1 open niche, 2 side bottle holders. Reversible left/right assembly
-



FUMAY 100 CUPBOARD

3401 : L100 x H186 x D45cm,
Weight : 65kg ; Volume : 0.159m3;
Number of packages : 2



FUMAY 76 CUPBOARD

803343 : L75 x H81 x D40cm,
Weight : 21kg ; Volume : 0.049m3;
Number of packages : 1

Kitchen—Unitary Furniture / Gala



✦ Mix storage and style with the GALA

✦ Gala includes a 180 cm high cupboard with 2 doors, interior shelves and a long drawer. Its niches of different sizes give it a contemporary look and make it easy to store. A second cupboard, 120cm high, has 1 door, 1 drawer and 1 open niche.

✦ The sideboard completes the storage with its door, drawer and open niches. It can be used as a work surface or as a place for your household appliances.

✦ The two-tone Gala **Jackson Oak** and **White Stone** provides a natural look that is intensified by the claustra-style profiled panels.



The products are made in particleboard with a thickness of 15 mm

Drawers are fitted with ball bearing slides

JACKSON OAK

WHITE STONE



The GALA natural range includes :

- A 180cm high cupboard with 1 drawer, 2 doors and 1 interior shelf. It has 5 open niches and grey handles.
- A 120cm high cupboard with 1 door with interior shelf, 1 drawer and niche. Grey handles
- A sideboard with 1 door and interior shelf, a drawer and 2 open niches. A credenza-type panel. Grey handles



3436 : L83 x H 182 x D40cm,
Weight : 45kg, Volume : 0.095m3;
Number of packages : 2



803375 : L61 x H120 x D44cm,
Weight : 27kg, Volume : 0.091m3,
Number of packages : 2



803376 : L120 x H99 x D40cm,
Weight : 35kg, Volume :
0.084m3; Number of packages : 1

Kitchen – Single Unit / Hub



✦ Transform your kitchen space with our HUB high table, the ideal solution for creating a functional table even in small spaces. Cleverly combining storage and a snack counter, this table becomes the heart of your kitchen.

✦ Our high table offers three large shelves, providing generous storage space to easily organize your kitchen utensils, spices, and much more. It is the perfect solution for storage needs while maintaining easy access to your essentials.

✦ The metal legs of the high table are a key element combining strength and lightness. They provide a robust base while giving the whole a visually light appearance. This ingenious combination creates a perfect balance between functionality and aesthetics.

✦ Choose an elegant aesthetic with our **White** high table featuring a **Jackson Oak** worktop. The contrast between bright white and oak brings a touch of modernity and natural warmth to your kitchen.

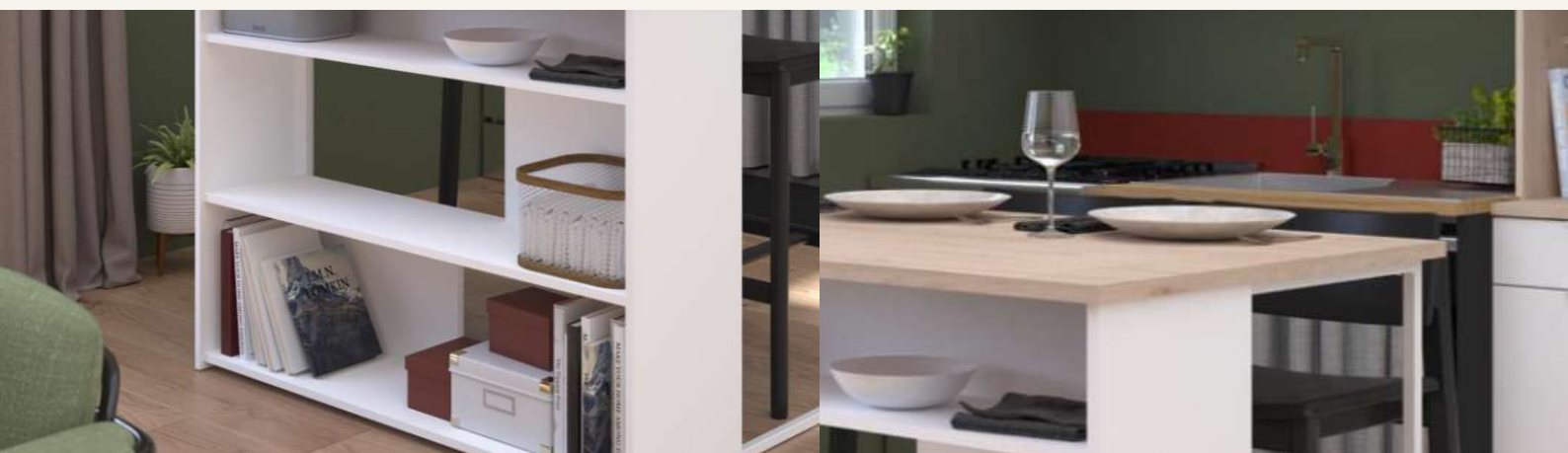

The products are made of particleboard, with a thickness of 16 and 22 mm.

WHITE

JACKSON OAK



The nature-style high table HUB includes :

- 22 mm thick worktop for a substantial appearance
- White lacquered metal legs: providing both visual lightness and good resistance
- 3 large shelves



LOT HUB BLC/CH.JACK.

803319 : L116 x H90 x P80cm,

Weight : kg 38; Volume : 0.100m³;

Number of packages : 2

Kitchen—Unitary Furniture / Malice



✚ Complete, clever kitchen storage accessories with MALICE

✚ The malice range includes two cupboards, one with 3 high and 3 low doors plus a drawer. The second has 2 high doors and 2 low doors with a drawer, more suited to smaller spaces. Its 2-door sideboard with drawer is practical thanks to its removable castors.

✚ The central island in the range is functional, incorporating 2 shelves, one of which is concealed under a door.

✚ Malice comes in two contemporary colours, **Nebraska Oak & Grey** or **Concrete & Grey**, adding character to your space.



The products are made in particleboard with a thickness of 15 mm

Drawers are fitted with ball bearing slides

NEBRASKA OAK

CONCRETE

GREY

GREY



The MALICE kitchen furniture range includes :

- A 120cm long cupboard with 1 drawer, 6 doors and 4 shelves inside. It includes a grey credenza and black plastic handles.
- An 80cm long cupboard with 1 drawer, 4 doors and 2 shelves inside. It includes a grey splashback and black plastic handles.
- A 60cm long sideboard on multifunctional castors. Includes 2 doors and drawer. Black plastic handles
- Central kitchen unit with 1 door and shelf



BUF.80 MALICE
L82 x H 180 x D44cm,
Number of packages : 2
Nebraska Oak : 3413
Concrete : 3412



BUF.120 MALICE
L120 x H180 x D44cm,
Number of packages : 2
Nebraska Oak : 3416
Concrete : 3415



DES.60 MALICE
301140 : L60 x H82 x D44cm,
Number of packages : 1
Nebraska Oak : 803362
Concrete : 803361



ILOT MALICE
L103 x H84 x P65cm,
Number of packages : 1
Nebraska Oak : 803368
Concrete : 803369



✚ The Malo cupboard combines functionality and elegance, offering generous storage space while adding a designer touch to your home.

✚ With its 3 doors and 5 interior shelves, Malo lets you hide your kitchen essentials out of sight. The 3 open niches are ideal for your small appliances, such as a microwave, while the built-in drawer provides a practical place for your cutlery or everyday accessories.

✚ Dressed in an elegant two-tone of **White, Shiny White** and **Cabezone Oak**, Malo fits in perfectly with a modern industrial style. Whether in your kitchen or living room, it will blend harmoniously with your décor.



0829BU3P : L80 x H185 x D43m, Weight : 53kg, Volume : 0.121m³, Number of packages : 2

Kitchen / Moove



✦ **Moove** reinvents traditional cuisine in a contemporary style with a cosy, warm touch.

✦ Modularity is at the heart of our design. Personalise your kitchen space with 4 carefully selected elements, offering flexibility and functionality. From clever storage spaces to organisational solutions, each element is designed to meet your specific needs, creating a kitchen that's just like you.

✦ Our new ergonomic 95 cm standard gives you a much more optimised space. The elements of your kitchen are designed to park your utensils within easy reach, allowing you to prepare your favourite dishes in optimum comfort.

✦ Immerse yourself in a contemporary aesthetic with shades of **Shadow Grey** and **River Oak**. The clean lines and Oak colour finishes create a sophisticated atmosphere, making your kitchen a stylish and welcoming space.



The products are made in particleboard with a thickness of 15 mm

The drawers are fitted with a metal roller runner system with shock absorber.

SHADOW GREY

RIVER OAK



The contemporary **MOOVE** kitchen includes :

- Base unit with 2 drawers and 2 saucepans
- 2-door base unit
- A column for the oven with 2 doors and 1 drawer
- Credenza with shelf support and 220 V and USB socket outlet
- Drawers with 16 mm thick bottoms and shock absorbing system



MOOVE BAS CUI.2PO2TI
0430BAPT: L118 x H95 x P60cm,
 Weight : 54.4kg ; Volume :
 0.138m³; Number of packages : 2



MOOVE CREDENCE
0430BAHT: L118 x H93 x P15cm,
 Weight : 18kg ; Volume :
 0.073m³; Number of packages :



MOOVE BAS CUI.2P
0430BA2P: L118 x H95 x P60cm,
 Weight : 47.7kg ; Volume :
 0.135m³; Number of packages :



MOOVE COLONNE
0430COFO : L63 x H188 x P60cm,
 Weight : 57.5kg ; Volume :
 0.131m³; Number of packages : 2

Kitchen - Single Unit / Socool



✦ SOCPOOL: a very complete multifunctional solution !

✦ The Socool storage unit offers you 3 doors with interior shelves and a drawer to store your dishes, glasses, and cutlery. Its open niches allow you to place, for example, your microwave, facilitated by the cable passage system in the countertop.

✦ Its back integrates a metal bar to add a hanging function, an essential function for kitchen utensils.

✦ Its current Scandinavian style is bright with its mix of **White** and **Jackson Oak** colours.



BUFFET SOCOOL 100

3389 : L100 x H186 x P45m,
Weight : 60kg, Volume : 0.136m³,
Number of packages : 2

The products are made of particleboard, with a thickness of 15 mm.

The drawer is equipped with a ball-bearing slide system.

WHITE

JACKSON OAK



✦ Bring efficiency and simplicity to your kitchen with our essential white under-sink available in 4 configurations. Redefine your space with a sleek design that combines functionality and an attractive price.

✦ Maximize the efficiency of your kitchen with generous storage space under the sink. Whether with 2 doors in 80, 100, and 120 cm or 3 doors in 120 cm, this design ensures optimal organization for cleaning products, garbage bags, and other essential items.

✦ The **White** colour gives your under-sink cabinet a timeless and minimalist aesthetic. Whether you choose 2 or 3 doors, its simplicity harmonizes with all kitchen styles, adding a touch of freshness and brightness to your space.



SOUS EVIER BLC 2P 80
7250 : L80 x H 82.8 x P 59.2cm;
 Weight : 25kg, Volume : 0.054m3,
 Number of packages : 1



SOUS EVIER BLC 2P 120
7252 : L120 x H 82.8 x P 59.2cm;
 Weight : 31.5kg, Volume :
 0.075m3, Number of packages : 1



SOUS EVIER BLC 2P 100
7251 : L100 x H 82.8 x P 59cm;
 Weight : 27kg, Volume : 0.064m3,
 Number of packages : 1



SOUS EVIER BLC 3P 120
7253 : L120 x H 82.8 x P 59.2cm;
 Weight : 32kg, Volume :
 0.075m3, Number of packages :

Kitchen / Spoon



✦ Our collection offers a culinary experience where contemporary design meets ingenious functionality. Discover SPOON, a versatile kitchen that will meet your needs and fit your space.

✦ Our kitchen is thoughtfully designed to fit your living space, whether it is large or small. With a careful selection of 12 elements, modularity is key. Create a personalized space with these 100% One Box "all-in-one" products, offering clever storage solutions and a functional layout to maximize efficiency.

✦ Our kitchen adapts to all lifestyles. The modular elements are ergonomically arranged, providing easy access to every utensil and optimizing your space.

✦ The white color and silver handles bring a touch of timeless elegance to your kitchen. Whether you have a modern, classic, or contemporary style, our kitchen harmonizes perfectly with any decor, creating a bright and welcoming ambiance.



The products are made of particleboard, with a thickness of 16mm.

The drawers feature ball-bearing slides, and the deep drawers have roller systems.

WHITE



The kitchen SPOON includes:

- Vertical top unit of 40, 60cm in height with 1 door or 80cm with 2 doors
- A horizontal top unit with 1 door, 60cm in height
- A base unit cabinet of 40cm with 1 door and 1 drawer and one with 3 drawers
- Base unit 60 with 1 door and one integrating 2 drawers
- Base unit 80cm with 2 doors and 2 drawers
- Base unit 120cm with 2 doors
- Space to accommodate the oven with or without doors
- A horizontal drawer 15cm wide



SPOON BLANC H58 H 4
245301 : L40 x H58 x P36cm;
 Weight : 12kg - Volume : 0.026m3;
 Packages : 1



SPOON B.1T1P P60 B 4
245309 : L40 x H86 x P60cm;
 Weight : 25kg - Volume : 0.063m3;
 Packages : 1



SPOON BL.2T2P P60 B 8
245314 : L80 x H86 x P60cm;
 Weight : 41kg - Volume : 0.079m3;
 Packages : 1



SPOON BLANC H58 H 6
245302 : L60 x H58 x P36cm;
 Weight : 15kg - Volume : 0.039m3;
 Packages : 1



SPOON BLA. 1P P60 B 6
245313 : L60 x H86 x P60cm;
 Weight : 28.5kg - Volume : 0.066m3;
 Packages : 1



SPOON BLANC 1T2TC 60
245312 : L60 x H86 x P60cm;
 Weight : 31kg - Volume : 0.075m3;
 Packages : 1



SPOON BLANC H58 H 8
245303 : L80 x H58 x P36cm;
 Weight : 19kg - Volume : 0.041m3;
 Packages : 1



SPOON BLAN.1P P60 B 4
245329 : L40 x H86 x P60cm;
 Weight : 23kg - Volume : 0.063m3;
 Packages : 1



SPOON BLANC P60 F60
245343 : L60 x H86 x P60cm;
 Weight : 22kg - Volume : 0.055m3;
 Packages : 1



SPOON BLANC H35 H06
245305 : L60 x H36 x P36cm;
 Weight : 10kg - Volume : 0.024;
 Packages : 1



SPOON BLA. 2P P60 B 8
245344 : L80 x H86 x P60cm;
 Weight : 35kg - Volume : 0.079m3;
 Packages : 1



SPOON BLA.1/2ARM60FOU
245339 : L60 x H141 x P60cm;
 Weight : 39kg - Volume : 0.084m3;
 Packages : 1

Kitchen – Single Unit / Spoon



✚ Combining practicality and design at a low price, SPOON adapts perfectly to all interiors.

✚ The large central niche allows for the integration of appliances such as a microwave, espresso machine, and other small appliances, simplifying your daily kitchen routine. It complements the range perfectly.

✚ Accessibility and quality meet in our range. With an attractive price, these furniture pieces offer functional storage solutions without compromising your budget. Transform your kitchen without sacrificing style or practicality.

✚ Spoon is available in a contemporary **white** colour. The grey aluminum feet and handles give these furniture pieces a modern and sleek style.



50 BUFFET 101 SPOON BLC
3363 : L101 x H184 x P40cm,
Weight : 52kg ; Volume :
0.119m3; Number of packages : 2



70 DESS.SPOON BLANC 1T2P
803308 : L60 x H85 x P40cm,
Weight : 19kg ; Volume :
0.047m3; Number of packages : 1

The products are made of particleboard with a thickness of 16 mm.

The drawers are equipped with ball-bearing slides.

WHITE



✦ The STUDIO wardrobe gives you more storage space without compromising on design.

✦ With 2 doors, one of which is full-height, you'll be able to keep all your kitchen essentials out of sight thanks to the 5 shelves inside the Studio unit. Your cutlery will find its place in the drawer under the niches. And the 3 open niches are perfect for storing your small appliances.

✦ With its industrial look in two-tone **Jackson Oak** and **Black Stipple**, Studio will look equally at home in your kitchen or living room.



STUDIO 100 CUPBOARD

3411 : L100 x H206 x D40cm,
Weight : 64kg, Volume :
0.153m³, Number of packages : 2

The products are made in particleboard with a thickness of from 15 mm.

Drawer fitted with ball bearing slides

BLACK STIPPLE

JACKSON OAK

Kitchen / Uno



✦ Choose a safe bet with our timeless, minimalist UNO kitchen, featuring all the storage essentials

✦ Modularity is the key to this 100% one-box kitchen. With modular units, you can create a made-to-measure kitchen to suit your lifestyle. Every element has been designed to optimise space, from clever storage to the intelligent layout of preparation areas.

✦ The large metallic finish handles are not just an aesthetic detail, but also a functional choice. They are easy to grip and add a modern touch to the kitchen, while making it easier to open doors and drawers.

✦ Its **White** colour makes UNO a neutral canvas that offers infinite flexibility to express your style. Our kitchen embodies timeless elegance with its clean lines, creating a luminous space.



The products are made in particleboard with a thickness of from 16 mm.

WHITE



Our minimalist UNO kitchen includes :

- Vertical wall units 40, 60cm high with 1 door or 80cm high with 2 doors
- 1-door horizontal wall unit 60cm high
- Base units with 1 door available in 40 and 60cm wide
- Base units with 1 door and 1 drawer available in 40 and 60cm wide and 60cm deep or one unit 40cm wide and 47cm deep
- 2-door base unit 60cm wide
- Base units with 2 doors and 1 drawer 80cm wide available in 47 or 60cm depth
- Space for oven



70 UNO WHITE H58 H 4
243101 : L40 x H58 x D35cm;
 Weight : 12kg - Volume : 0.026m³; Number of packages : 1



70 UNO WHITE 1T1P P47 E 4
243159 : L40 x H86 x D47cm;
 Weight : 22kg - Volume : 0.047m³; Number of packages : 1



70 UNO WHITE 2P P60 B 8
243144 : L80 x H86 x D60cm;
 Weight : 35kg - Volume : 0.079m³; Number of packages : 1



70 UNO WHITE H58 H 6
243102 : L60 x H58 x D35cm;
 Weight : 15kg - Volume : 0.039m³; Number of packages : 1



70 UNO WHITE 1T1P P60 B 4
243109 : L40 x H86 x D60cm;
 Weight : 25kg - Volume : 0.063m³; Number of packages : 1



70 UNO WHITE 1T2P P47 E 8
243164 : L80 x H86 x D47cm;
 Weight : 31kg - Volume : 0.063m³; Number of packages : 1



70 UNO WHITE H58 H 8
243103 : L80 x H58 x D35cm;
 Weight : 19kg - Volume : 0.041m³; Number of packages : 1



70 UNO WHITE 1T1P P60 B 6
243111 : L60 x H86 x D60cm;
 Weight: 31kg- Volume : 0.079m³; Number of packages : 1



70 UNO WHITE 1T2P P60 B 8
243114 : L80 x H86 x D60cm;
 Weight : 36kg - Volume : 0.079m³; Number of packages : 1



70 UNO WHITE H35 H06
243105 : L60 x H35 x D35cm;
 Weight : 10kg - Volume : 0.024m³; Number of packages : 1



70 UNO WHITE 1P P60 B 6
243113 : L60 x H86 x D60cm;
 Weight : 28kg - Volume : 0.066m³; Number of packages : 1



70 UNO WHITE P60 F60
243143 : L60 x H86 x D60cm;
 Weight : 22kg - Volume : 0.055m³; Number of packages : 1



70 UNO WHITE 1P P60 B 4
243129 : L40 x H86 x D60cm;
 Weight : 23kg - Volume : 0.063m³; Number of packages : 1

Kitchen / Uno Oak



✚ Choose a reliable option with our UNO kitchen, now available in an Oak finish. Its timeless and minimalist style combines with essential storage solutions for a complete and practical package.

✚ Modularity is the key to this 100% one-box kitchen. With modular elements, create a custom kitchen that adapts to your lifestyle. Each of the 12 available elements is designed to optimize space, from clever storage to the intelligent arrangement of preparation areas.

✚ The large white-finished handles, both aesthetic and functional, ensure optimal grip and add a modern touch to the overall look. This kitchen can be mixed with the UNO white kitchen, as well as the buffet & sideboard ranges, and UNO kitchenette & laundry.

✚ The oak finish adds natural and authentic warmth to your space, while the neutral and bright white offers endless flexibility to express your style.



The products are made in particle board with a thickness of 16mm.
Drawers are equipped with ball-bearing slides.

JACKSON OAK

Kitchen / Uno Oak



Our minimalist UNO kitchen includes:

4 Wall Cabinets (Height 58 x Depth 35 cm)

- Wall Cabinet L40 1 door / Wall Cabinet L60 1 door / Wall Cabinet L80 2 doors
- Short Wall Cabinet L60 1 door (Height 35 cm)

8 Base Cabinets (Height 86.6 x Depth 60 cm)

- Base unit L40 1 door / Base Cabinet L40 1 door + 1 drawer
- Base unit L60 1 door / Base Cabinet L60 1 door + 1 drawer
- Base unit L60 oven / Base Cabinet L60 3 drawers
- Base unit L80 2 doors / Base Cabinet L80 2 doors + 1 drawer

- **Box unit** : 16mm-thick melamine particleboard in matte white decor with matching edges.
- **Fronts**: 16mm-thick melamine particleboard in Jackson Oak decor (one side) with matching edge decor.
- **Worktop**: 22mm-thick melamine particleboard in matte white decor with matching edges.
- **Handles**: Metallic-look ABS with 160mm spacing.
- **Back** : White decor fiberboard (one side).
- **Base unit** : Equipped with 4 adjustable feet.



0832HA40 : L40 x H58 x P35cm;
Weight : 12kg - Volume : 0.026m3; Number of packages : 1



0832BP60 : L60 x H86 x P60cm;
Weight : 29kg - Volume : 0.064m3; Number of packages : 1



0832BP80 : L80 x H86 x P60cm;
Weight : 35kg - Volume : 0.079m3; Number of packages : 1



0832HA60 : L60 x H58 x P35cm;
Weight : 15kg - Volume : 0.039m3; Number of packages : 1



0832BA40 : L40 x H86 x P60cm;
Weight : 25kg - Volume : 0.063m3; Number of packages : 1



0832BA80 : L80 x H86 x P60cm;
Weight : 36kg - Volume : 0.079m3; Number of packages : 1



0832HA80 : L80 x H58 x P35cm;
Weight : 19kg - Volume : 0.041m3; Number of packages : 1



0832BA60 : L60 x H86 x P60cm;
Weight : 31kg - Volume : 0.079m3; Number of packages : 1



0832BAFO : L60 x H86 x P60cm;
Weight : 23kg - Volume : 0.055m3; Number of packages : 1



0832HC60 : L60 x H35 x P35cm;
Weight : 10kg - Volume : 0.024m3; Number of packages : 1



0832BT60 : L60 x H86 x P60cm;
Weight : 31kg - Volume : 0.075m3; Number of packages : 1



0832BP40 : L40 x H86 x P60cm;
Weight : 23kg - Volume : 0.063m3; Number of packages : 1



✚ Add timeless storage to your kitchen with UNO unitary furnitures

✚ The kitchen range includes 2 cupboards, one of which is 90cm long with 4 drawer doors and multiple shelves. For smaller spaces, a second 60cm long cupboard with 2 doors, 1 drawer, 2 shelves and space for a microwave.

✚ The cupboard in the range lets you add storage with 2 doors containing a shelf and a drawer. Its castors make it easy to move around the kitchen or living room.

✚ A timeless style with a **White** look that will match all the furniture in the range.



3434 : L90 x H177 x D43cm, Weight : 49kg, Volume : 0.116m3, Number of packages: 2



803357 : L60 x H177 x D43cm, Weight : 39kg, Volume : 0.085m3, Number of packages: 1



803358 : L60 x H76 x D43cm, Weight : 21kg, Volume : 0.050m3, Number of packages: 1



✦ Designed for small spaces, our UNO kitchenette combines practicality and design in an optimized format.

✦ Its two tall doors offer generous storage space for your utensils or groceries, while the integrated niche perfectly accommodates your microwave or other small appliances.

✦ With its modern and clean style, featuring Jackson Oak & Matte White decor, this kitchenette fits all types of interiors, making it the ideal solution for studios, apartments, or professional spaces.

✦ The kitchenette can be complemented with the kitchen furniture, buffets & sideboards from the UNO OAK range.

Product Description :

- **Structure** : 16mm-thick melamine particleboard in matte white decor with matching edges.
- **Fronts** : 16mm-thick melamine particleboard in Jackson Oak decor with matching edges.
- **Worktop**: 22mm-thick melamine particleboard in matte white decor with matching edges. *
- **Handles**: Metallic-look ABS with 160mm spacing.
- **Back** : White decor fiberboard.



0832CUI5 : L120 x H203 x P60m, Weight : 64.5kg, Volume : 0.146m³, Number of packages : 2

Kitchen / Wave



✦ Discover our WAVE kitchen, where the boldness of grey meets the authenticity of oak, creating a perfect blend of modernity and tradition, where contemporary style meets timeless elegance.

✦ Redefine the space in your kitchen with not one, but 3 central islands. These multi-purpose areas provide extra space for meal preparation, creating a convivial meeting point for your family and friends.

✦ Wave includes a dedicated space for the oven, harmoniously integrated for practical use. The 11 modular elements allow you to organise your utensils and provisions with maximum efficiency, while the two worktops in traditional rustic style add character to the composition.

✦ The combination of deep **Aran Grey** and **Natural Oak** creates an aesthetic that exudes rustic charm. The oak-coloured edgings add a subtle visual dimension, while the worktop in Raw Oak veneer with a raw oak solid wood panel lends authenticity to the space, creating a traditional ambience with a modern twist.



*The products are made in particleboard with a thickness of 16mm
Roller runners on drawers and pot-and-pan drawers with shock-absorbing system.*

ARAN GREY

NATURE OAK



WAVE's revisited traditional cuisine includes :

- A free-standing central island with 2 sliding doors
- A free-standing central island with 1 door and 3 drawers
- A central island on legs with 2 doors
- A column with space reserved for the oven
- A 60cm wide wall unit and a 120cm wide wall unit
- A column with shelves, doors and a vertical drawer
- A space for a refrigerator with door
- Worktop dimensions: 120 and 180cm
- A finishing back to clip onto the base unit



WAVE BAS 120 2P COUL

244615 : L120 x H91 x P60cm;
Poids : 50kg - Volume : 0.119m3;
Colis : 2



WAVE ETAG NICHE CARRE

244660 : L60 x H60 x D24cm;
Weight : 10kg - Volume : 0.023m3;
Number of Packages : 1



WAVE COL 60 FOUR

244637 : L60 x H196 x D60cm;
Weight : 55kg - Volume : 0.129m3;
Number of Packages : 2



WAVE BAS 120 1P3T

244617 : L120 x H91 x P60cm;
Poids : 68kg - Volume : 0.141m3;
Colis : 2



WAVE ETAG NICHE RECT.

244661 : L120 x H35 x D20cm;
Weight : 10kg - Volume : 0.022m3;
Number of Packages : 1



WAVE COL 60 1T1P

244649 : L60 x H196 x D60cm;
Weight : 60kg - Volume : 0.148m3;
Number of Packages : 2



WAVE BAS 120 2P

244616 : L120 x H91 x P60cm;
Poids : 50kg - Volume : 0.119m3;
Colis : 1



PT WAVE CHENE 2,5 180

193018 : L180 x H2.5 x D67cm;
Weight : 23kg - Volume : 0.064m3;
Number of Packages : 1



WAVE COL 60 IFR

244648 : L60 x H196 x D60cm;
Weight : 61kg - Volume : 0.143m3;
Number of Packages : 1



WAVE HABILL.ILOT 120

244679 : L120 ; Poids : 11kg -
Volume : 0.030m3; Colis : 1



PT WAVE CHENE 2,5 120

193012 : L120 x H2.5 x D67cm;
Weight : 16kg - Volume : 0.039m3;
Number of Packages : 1



SANITARY



✦ Optimize every corner of your bathroom with our range of sanitary furniture FLASH 2, designed to offer you maximum functionality.

✦ The combinable storage units, specially designed to be installed above the toilet and under your sink, allow for optimal organization. Their doors offer spacious and closed storage complemented by a placement shelf or a shelf for easy access to elements.

✦ Our column storage units with one or two doors offer you total flexibility. The mirrors, whether single or integrated into the columns, add an extra dimension to your bathroom by meeting your daily needs, reflecting light, and enlarging the space.

✦ Organize your daily essentials while maintaining visual harmony with our bright and timeless **White** elements.



The products are made of particleboard, with a thickness of 16 mm.

WHIT

The drawers are equipped with a metal ball-bearing and roller slide system



The FLASH 2 sanitary furniture range includes:

- A column equipped with a drawer and 2 doors, one with a mirror
- A column equipped with an inner drawer and a mirrored door
- A toilet surround with a shelf and 2 doors
- A unit to place under the sink with 2 doors
- A large mirror with a shelf



FLASH II CHAND C59

602715 : L59 x H184 x P31cm,
Weight : 37kg ; Volume : 0.087m³;
Number of packages : 1



FLASH II S.LAV SL6

602725 : L59 x H55 x P38cm, Weight :
14kg ; Volume : 0.031m³; Number of
packages : 1



FLASH II CHAND C29

602714 : L29 x H184 x P31cm,
Weight : 25kg ; Volume : 0.056m³;
Number of packages : 1



2435 BLANC MIRO.MI6

2435 : L60 x H58 x P11cm, Weight :
7kg ; Volume : 0.018m³; Number of
packages : 1



ENTOU.W.C BLC.POR.CHA

2047 : L60 x H180 x P21cm, Weight :
18kg ; Volume : 0.046m³; Number of
packages : 1

Sanitary / Glam



✦ Immerse yourself in the perfect union of modern aesthetics modern aesthetics and practical organisation with our range of furniture for GLAM washrooms.

✦ Turn your bathroom into a unique space with our 4 modular storage units. Columns, a vanity unit and a multi-function surround, each piece of is designed to adapt to your lifestyle, offering personalised organisation without compromising without compromising on design.

✦ GLAM offers a contemporary design offering a range in **Shiny White**, bringing a chic luminosity to your bathroom. The range is also available in **Shiny Grey** for a sober, modern look.



The products are made of particleboard, with a thickness of 16 mm.

The drawers are equipped with a ball-bearing slide system.

SHINY GREY

SHINY WHITE



The contemporary range with glossy colours GLAM includes :

- Under-sink cabinet, 2 doors, 1 shelf
- Multifunctional over storage cabinet (for washing machine or toilet), 1 shelf
- 2 columns with doors + drawer in 30 and 60 widths, 2 shelves
- Aluminum handles with matte gray finish on Glam Gray and matte black lacquer on Glam White



GLAM COL.4P1T C60

L60 x H182 x P32cm, Weight : 36kg;
Volume : 0.081m³; Number of packages : 1

SHINNY WHITE : **726704**

SHINNY GREY : **726804**



GLAM COL.2P1T C30

L30 x H182 x P32cm, Weight : 24kg;
Volume : 0.081m³; Number of packages : 1

SHINNY WHITE :- **726703**

SHINNY GREY : **726803**



GLAM ENT WCLL64

L64 x H184 x P22cm, Weight : 20kg;
Volume : 0.052m³; Number of packages : 1

SHINNY WHITE : **726737**

SHINNY GREY : **726837**



GLAM S.LAV.SL6

L60 x H58 x P38cm, Weight : 14kg;
Volume : 0.044m³; Number of packages : 1

SHINNY WHITE : **726705**

SHINNY GREY : **726805**



✚ Transform your utility room into a functional, tidy space with our range of LAUNDRY combinable units.

✚ Our washer/dryer cabinet with rail lets you hang up your freshly washed clothes. The washer or dryer module and shelves provide additional storage for detergents and accessories, ensuring that everything is within easy reach. Storage solutions with two baskets give you organized space to sort and store your clothes, while our wide cabinet with two baskets and side storage for vacuum cleaner or broom makes it easy to access your bulky household tools.

✚ The dressing room kit with curtain is a real asset for optimizing your space, allowing you to stack a washing machine and tumble dryer on top of each other. This modular system adapts to your needs, whether for storing baskets, clothes or household equipment, allowing you to make the most of your laundry room, whatever its size.

✚ With its clean, modern design, the Laundry range combines aesthetics and practicality, with its Jackson Oak and White adding a contemporary touch to your laundry room. Make your laundry room a pleasant, welcoming place, where each piece of furniture blends harmoniously with your interior decor.



The products are made in particule board, with a thickness of 16 mm

JACKSON OAK

WHITE



The LAUNDRY laundry storage range includes :

- Washing machine or dryer module with hanging rail
- A module with 2 spaces for baskets as well as a high door and a side door.
- A module for washing machine or dryer with 2 shelves
- Kit dressing room with 100% polyester curtain. Ideal for stacking a washing machine and dryer.
- A module with 2 low spaces for baskets and a high door



1074DRES : L.: 113 x H.: 184 x P. : 70 cm; Weight : 64.3kg; Volume : 0.148m³; Number of packages : 2



1074RA4B : L: 92 x H.: 184 x P. : 70cm; Weight : 73kg; Volume : 0.154m³; Number of packages : 2



1074RA2B : L.: 65 x H.: 184 x P. : 66 cm; Weight : 38kg; Volume : 0.096m³; Number of packages : 1



1074RA3B : L: 47 x H.: 184 x P. : 66cm; Weight : 46.5kg; Volume : 0.099m³; Number of packages : 2



1074RA1B : L: 65 x H.: 184 x P. : 60cm; Weight : 33kg; Volume : 0.083m³; Number of packages : 1



✦ Transform your utility room into a functional space with LONDY! Designed to meet modern needs, this innovative storage system combines practicality and aesthetics, allowing you to maximise every inch of your space.

✦ LONDY offers two separate modules, specially designed to accommodate a washing machine or tumble dryer. You can compose your layout according to the space available, offering unrivalled flexibility to adapt to your specific needs.

✦ Londy has a contemporary look. Its white finish adds a touch of light to your utility room, while keeping it well organised.





The LONDY laundry storage range includes :

- An 80cm storage unit with space for a washing machine or tumble dryer, 3 shelves and a vertical niche for an ironing board. This module can be fitted with the niche on the left or right.
- 64cm storage unit with space for washing machine or tumble dryer



83 LONDY BOX A 64

303300 : L.: 64.2 x H.: 203.2 x P. : 60.3 cm; Weight : 45.2kg; Volume : 0.098m3; Number of packages : 2



83 LONDY BOX B 80

303301 : L: 80 x H.: 203.2 x P. : 60cm ; Weight : 61.3kg; Volume : 0.134m3 ; Number of packages : 2



✦ Functional and timeless, UNO sanitary furniture is a safe bet for optimising your laundry design.

✦ Storage without encroaching on your space with this surround, ideal for overhanging a washing machine or your WC. Its doors will keep your household or toilet products accessible.

✦ Its storage column with door is ideal for keeping your bathroom linen dust-free while organising your hygiene essentials. Ideal for small spaces, Uno will fit in perfectly without obstructing the flow of traffic in your room.

✦ Its **White** colour gives it a bright, modern look that you'll never tire of!



The products are made in particleboard with a thickness of 16 mm

WHITE

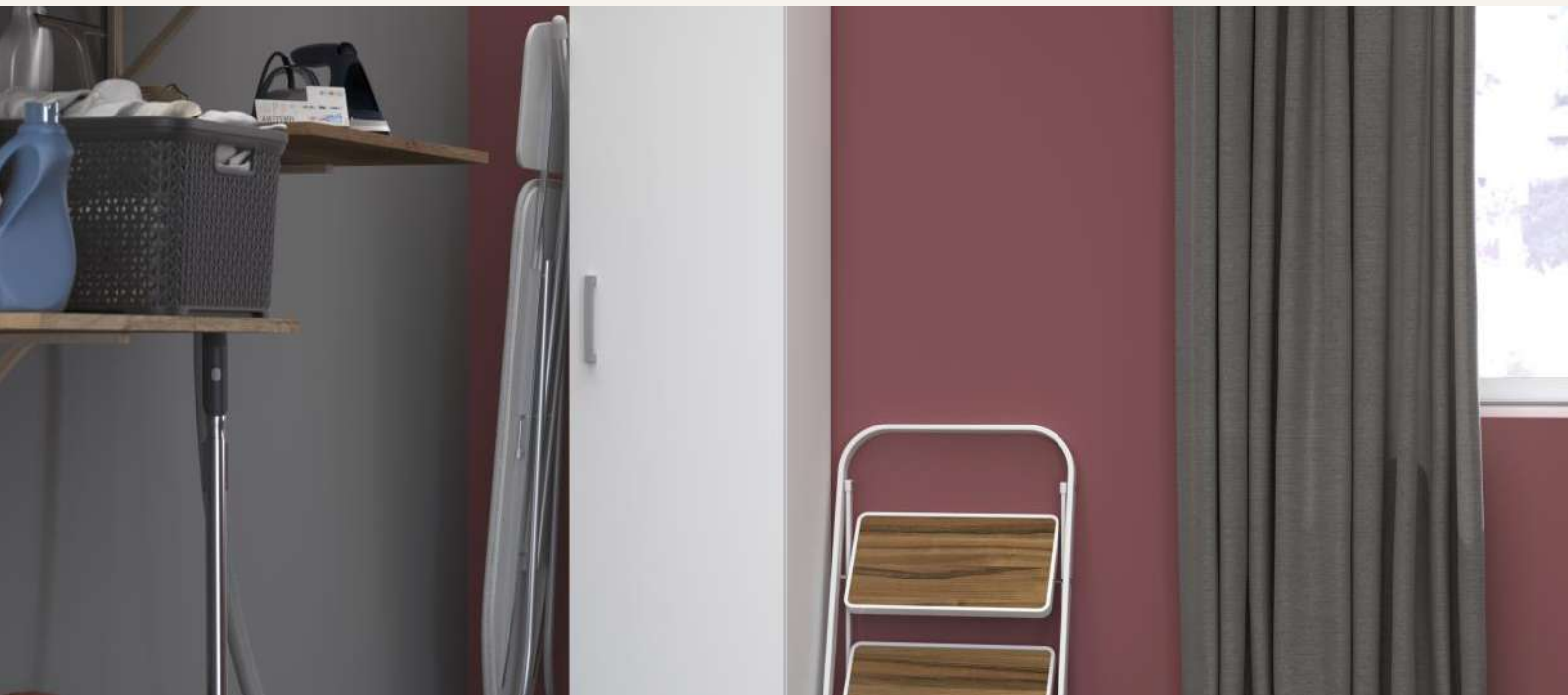

UNO range includes :

- A polyvalent enclosure with 2 doors and an interior shelf
- A storage column with doors, interior shelves and hooks



ENCLOSURE

803373 : L64 x H185 x D35cm,
Weight : 27kg ; Number of
packages : 1



COLUMN

803374 : L45 x H185 x D35cm,
Weight : 31kg ; Number of
packages: 1



✚ Redefine the space in your bathroom with our WOODY freestanding over storage cabinet, a functional and attractive storage solution.

✚ Optimise and add versatility to your space with the Woody over storage cabinet, ideal for overhanging the washing machine, WC or tumble dryer, this 2-door unit with shelves is a discreet solution for organising your bathroom essentials.

✚ Woody is a perfect balance between modern style and natural warmth, with its Scandinavian-inspired two-tone **Oak** and **White**.



WOODY OAK SURROUND

604837: L64 x H184 x D22cm, Weight: 20kg; Volume: 0.050m³; Number of packages: 1



PARISOT INDUSTRIE

